

08

ESTRATTORI





Estrattore universale a 2 griffe

- Griffe scorrevoli con sistema di bloccaggio a vite
- Presa esterna
- Griffe in acciaio Cromo Vanadio
- Vite in acciaio Cromo Vanadio

CODICE	A/mm	H griffa	€/Pz
FG 162/1	15 - 85mm	100 mm	71,60
FG 162/2	15 - 125mm	100 mm	73,70
FG 162/3	20 - 160mm	150 mm	134,90
FG 162/4	20 - 200mm	150mm	158,10
FG 162/5	40 - 250mm	200mm	252,40

Set 3 estrattori universali a 2 griffe

Contenuto: FG 162/1, FG 162/2, FG 162/3

CODICE	€/Pz
FG 162/S3	285,00



Griffa di ricambio per FG 162/1-FG 162/5

CODICE	PER:	€/Pz
FG 162/1-G1	FG 162/1	22,50
FG 162/2-G2	FG 162/2	23,50
FG 162/3-G3	FG 162/3	42,00
FG 162/4-G4	FG 162/4	45,00
FG 162/5-G4	FG 162/5	58,00



Vite centrale di ricambio per FG 162/1-FG 162/5

CODICE	PER:	€/Pz
FG 162/1-V1	FG 162/1	22,50
FG 162/2-V2	FG 162/2	22,50
FG 162/3-V3	FG 162/3	26,50
FG 162/4-V4	FG 162/4	26,50
FG 162/5-V4	FG 162/5	35,50



Estrattore a 2 griffe sottili

- Presa interna ed esterna
- Griffe intercambiabili super sottili in acciaio Cromo Vanadio
- Spessore griffa: 2mm
- Vite in acciaio Cromo Vanadio

CODICE	A/mm	B/mm	C/mm	€/Pz
FG 168/EF1	110	140	186	270,00
FG 168/EF2	195	140	186	280,00

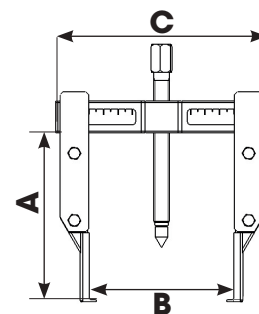

NEW

Griffa di ricambio per FG 168/EF1-FG 168/EF2

CODICE	PER:	€/Pz
FG 168/EF1-G1	FG 168/EF1	98,00
FG 168/EF2-G2	FG 168/EF2	105,00



Vite centrale di ricambio per FG 168/EF1-FG 168/EF2

CODICE	PER:	€/Pz
FG 168/EF1-V1	FG 168/EF1	45,00
FG 168/EF2-V1	FG 168/EF2	55,00

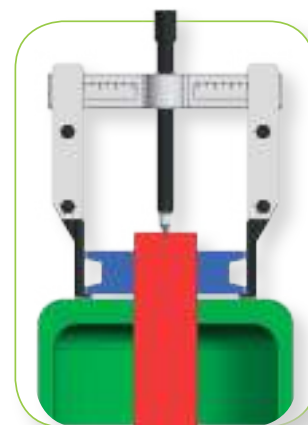

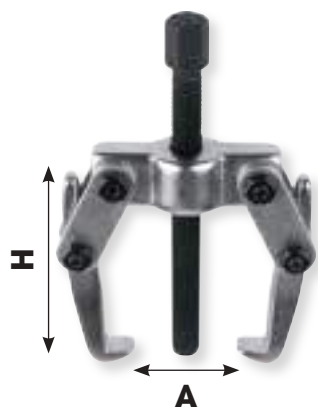

Estrattore a 2 griffe oscillanti

- Griffe in acciaio Cromo Vanadio
- Vite in acciaio Cromo Vanadio

CODICE	A/mm	H/mm	€/Pz
FG 162/ME	60 mm	85mm	28,00

Estrattore universale a 2 griffe **NEW**

- Presa esterna
- Griffe regolabili in acciaio Cromo Vanadio
- Vite in acciaio Cromo Vanadio

CODICE	A/mm	B/mm	C/mm	D/mm	€/Pz
FG 162/FR1	90	55	90	95	132,00
FG 162/FR2	125	70	120	125	170,00
FG 162/FR3	125	80	160	125	210,00

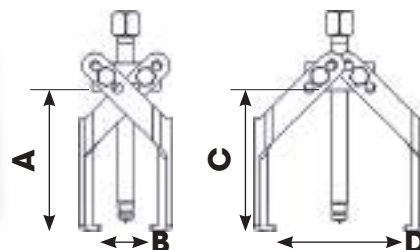

Estrattore a 3 griffe autoregolabili

- Presa esterna
- Griffe autoregolabili in acciaio Cromo Vanadio
- Vite in acciaio Cromo Vanadio
- Possibilità di montare griffe per presa interna (vedi codici FG 164/GR)

CODICE	∅ / mm	€/Pz
FG 163/1	7 - 140	182,00
FG 163/2	10 - 180	200,00
FG 163/3	20 - 260	252,00

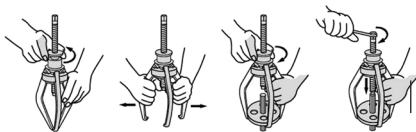

Griffa di ricambio per FG 163/1-FG 163/3

CODE	FOR:	€/Pz
FG 163/1-GR1	FG 163/1	22,00
FG 163/2-GR2	FG 163/2	25,00
FG 163/3-GR3	FG 163/3	30,00



Vite centrale di ricambio per FG 163/1-FG 163/3

CODE	FOR:	€/Pz
FG 163/1-V1	FG 163/1	27,00
FG 163/2-V2	FG 163/2	30,00
FG 163/3-V3	FG 163/3	35,00



Estrattore a 3 griffe autoregolabili

- Presa interna
- Griffe autoregolabili in acciaio Cromo Vanadio
- Vite in acciaio Cromo Vanadio
- Possibilità di montare griffe per presa esterna (vedi codici FG 163/GR)

CODICE	∅ / mm	€/Pz
FG 164/1	23 - 130	175,00
FG 164/2	50 - 170	218,00

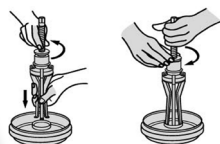

Griffa di ricambio per FG 164/1-FG 164/2

CODE	FOR:	€/Pz
FG 164/1-GR1	FG 164/1	16,00
FG 164/2-GR2	FG 164/2	19,00



Vite centrale di ricambio per FG 164/1-FG 164/2

CODE	FOR:	€/Pz
FG 163/1-V1	FG 164/1	27,00
FG 163/2-V2	FG 164/2	30,00



Kit estrattore per presa interna + griffe per presa esterna

CODICE	∅/mm	€/Pz
FG 163/S2B	7 - 140 per presa interna 50 - 170 per presa esterna	230,00





Estrattore autocentrante a 3 griffe

- Possibilità di 4 posizioni differenti
- Presa esterna
- Meccanismo autocentrante
- griffe con apertura per consentire una miglior presa su eventuali bulloni

CODICE	A/mm	B/mm	€/Pz
FG 165/1	120	125	250,00
FG 165/2	210	220	320,00
FG 165/3	270	280	470,00

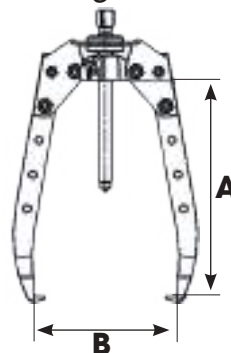

NEW



Estrattore idraulico autocentrante a 3 griffe

- Possibilità di 4 posizioni differenti
- Presa esterna
- Meccanismo autocentrante
- griffe con apertura per consentire una migliore presa su eventuali bulloni

CODICE	A/mm	B/mm	C/mm	€/Pz
FG 165/HI	270	280	4.5	870,00

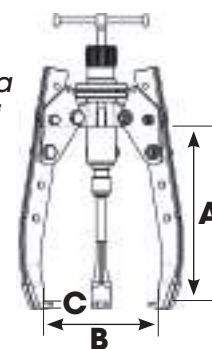

NEW



Griffa di ricambio per FG 165/1-FG 165/3 e FG 165/HI

CODICE	PER:	€/Pz
FG 165/1-G1	FG 165/1	30,00
FG 165/2-G2	FG 165/2	40,00
FG 165/3-G3	FG 165/3	58,00
FG 165/HI-G1	FG 165/HI	58,00



Vite centrale di ricambio per FG 165/1-FG 165/3

CODICE	PER:	€/Pz
FG 165/1-V1	FG 165/1	22,00
FG 165/2-V2	FG 165/2	34,00
FG 165/3-V3	FG 165/3	46,00

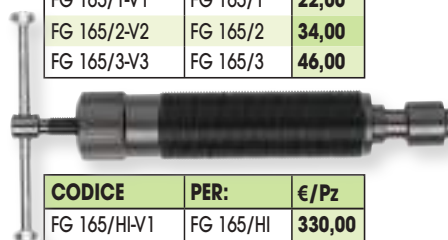

CODICE	PER:	€/Pz
FG 165/HI-V1	FG 165/HI	330,00

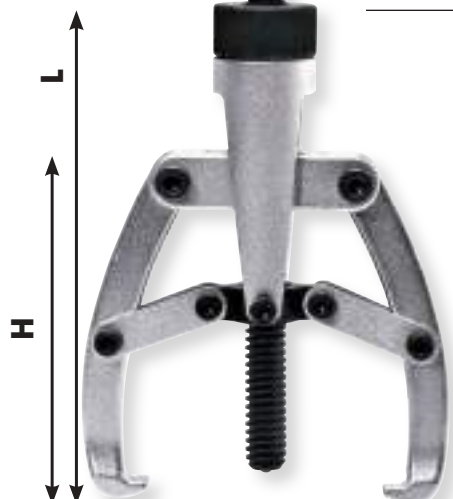

Estrattore manuale di grande potenza a 2 griffe

- Presa esterna
- Le leve di supporto ad ogni griffa moltiplicano la potenza garantendo livelli di forza elevati

CODICE	CAPACITA'	Apertura min-max	AxBxC/mm	HxL/mm	€/Pz
FG 160/1	2 Ton.	20 - 115mm	8x6x15	80x120	98,00
FG 160/2	5Ton.	30 - 240mm	11x10x25	160x250	218,00
FG 160/3	10Ton.	40 - 380mm	14x10x29	230x380	390,00



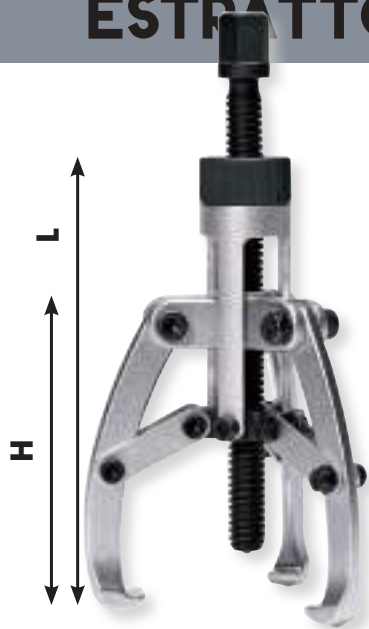

Estrattore manuale di grande potenza a 3 griffe

- Presa esterna
- Le leve di supporto ad ogni griffa moltiplicano la potenza garantendo livelli di forza elevati

CODICE	CAPACITA'	Apertura min-max	AxBxC/mm	HxL/mm	€/Pz
FG 161/1	2Ton.	28 - 112mm	8x6x15	80x120	110,00
FG 161/2	5Ton.	40 - 243mm	11x10x25	160x250	228,00
FG 161/3	10Ton.	46 - 370mm	14x10x29	230x380	430,00



Estrattore a 2/3 griffe

- Dotato di 3 griffe per presa interna e 3 griffe per presa esterna
- Griffe in acciaio Cromo Vanadio

CODICE	∅ internal	∅ esterna	€/Pz
FG 165/IE1	25-100mm	0-75mm	280,00
FG 165/IE2	45-150mm	40-130mm	680,00

NEW



Massa battente

- M12 X 1.5

CODICE	PER:	€/Pz
FG 165/MB1	FG 165/IE1	150,00
FG 165/MB2	FG 165/IE2	290,00

NEW



Estrattore a 2 griffe oscillanti

- Presa esterna
- Griffe in acciaio Cromo Vanadio

CODICE	A/mm	B/mm	C/mm	D/mm	Ton.	€/Pz
FG 160/GL1	80	80	10.7	7.90	1	78,00
FG 160/GL2	116	122	11.0	8.10	3	96,50
FG 160/GL3	160	161	14.2	11.1	5	148,00
FG 160/GL4	200	202	19.0	14.5	8	172,00

NEW

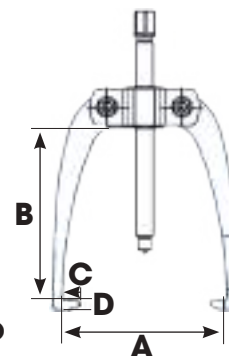

Griffa di ricambio

CODICE	PER:	€/Pz
FG 160/GL1-G1	FG 160/GL1	16,00
FG 160/GL2-G2	FG 160/GL2	16,00
FG 160/GL3-G3	FG 160/GL3	28,00
FG 160/GL4-G4	FG 160/GL4	36,00

Vite centrale di ricambio

CODICE	PER:	€/Pz
FG 160/GL1-V1	FG 160/GL1	20,00
FG 160/GL2-V2	FG 160/GL2	32,00
FG 160/GL3-V3	FG 160/GL3	45,00
FG 160/GL4-V4	FG 160/GL4	46,00



Estrattore a 3 griffe oscillanti

- Presa esterna
- Griffe in acciaio Cromo Vanadio

CODICE	A/mm	B/mm	C/mm	D/mm	Ton.	€/Pz
FG 161/GL1	80	80	10.7	7.90	1	96,00
FG 161/GL2	116	122	11.0	8.10	3	120,00
FG 161/GL3	160	161	14.2	11.1	5	185,00
FG 161/GL4	200	202	19.0	14.5	8	218,00

NEW

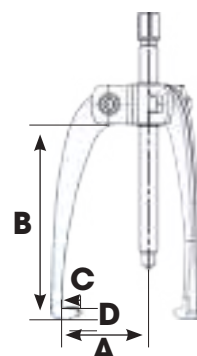

Griffa di ricambio

CODICE	PER:	€/Pz
FG 160/GL1-G1	FG 161/GL1	16,00
FG 160/GL2-G2	FG 161/GL2	16,00
FG 160/GL3-G3	FG 161/GL3	28,00
FG 160/GL4-G4	FG 161/GL4	36,00

Vite centrale di ricambio

CODICE	PER:	€/Pz
FG 160/GL1-V1	FG 161/GL1	20,00
FG 160/GL2-V2	FG 161/GL2	32,00
FG 160/GL3-V3	FG 161/GL3	45,00
FG 160/GL4-V4	FG 161/GL4	46,00



Estrattore a 2 griffe oscillanti

- Presa esterna
- Griffe in acciaio Cromo Vanadio

CODICE	A/mm	B/mm	C/mm	€/Pz
FG 160/OS1	105	110	70	85,00
FG 160/OS2	185	175	80	126,00
FG 160/OS3	225	240	113	190,00
FG 160/OS4	225	290	160	210,00
FG 160/OS5	400	350	161	360,00

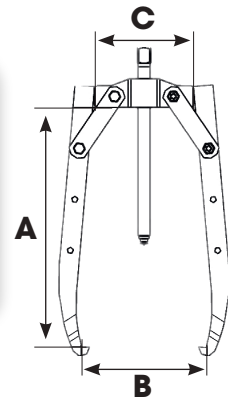
NEW**Griffa di ricambio**

CODICE	PER:	€/Pz
FG 160/OS1-G1	FG 160/OS1	16,00
FG 160/OS2-G2	FG 160/OS2	28,00
FG 160/OS3-G3	FG 160/OS3	40,00
FG 160/OS4-G4	FG 160/OS4	42,00
FG 160/OS1-G5	FG 160/OS5	85,00

Vite di ricambio

CODICE	PER:	€/Pz
FG 160/OS1-V1	FG 160/OS1	22,00
FG 160/OS2-V2	FG 160/OS2	35,00
FG 160/OS3-V3	FG 160/OS3	52,00
FG 160/OS4-V4	FG 160/OS4	65,00
FG 160/OS1-V5	FG 160/OS5	79,20

Estrattore a 3 griffe oscillanti

- Presa esterna
- Griffe in acciaio Cromo Vanadio

CODICE	A/mm	B/mm	C/mm	€/Pz
FG 161/OS1	105	110	80	130,00
FG 161/OS2	185	175	104	192,00
FG 161/OS3	225	240	108	260,00
FG 161/OS4	225	290	160	292,00
FG 161/OS5	400	350	161	580,00

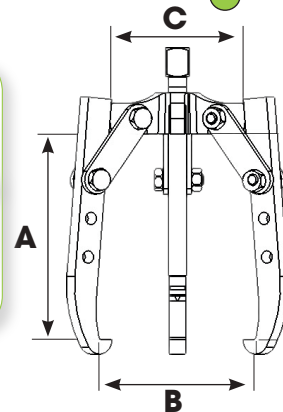
NEW**Griffa di ricambio**

CODICE	PER:	€/Pz
FG 160/OS1-G1	FG 161/OS1	16,00
FG 160/OS2-G2	FG 161/OS2	28,00
FG 160/OS3-G3	FG 161/OS3	40,00
FG 160/OS4-G4	FG 161/OS4	42,00
FG 160/OS1-G5	FG 161/OS5	85,00

Vite di ricambio

CODICE	PER:	€/Pz
FG 160/OS1-V1	FG 161/OS1	22,00
FG 160/OS2-V2	FG 161/OS2	35,00
FG 160/OS3-V3	FG 161/OS3	52,00
FG 160/OS4-V4	FG 161/OS4	65,00
FG 160/OS1-V5	FG 161/OS5	79,20

Martinetto idraulico

- Sistema di ritorno manuale
- 5 alzate
- Capacità: 9 Ton

CODICE	€/Pz
FG 162/MA1	295,00

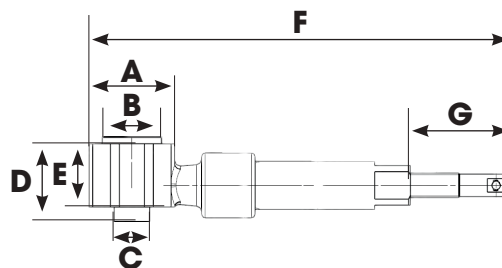
**NEW**

A/mm	B/mm	C/mm	D/mm	E/mm	F/mm	G/mm
48	34	20	43	35	238	58

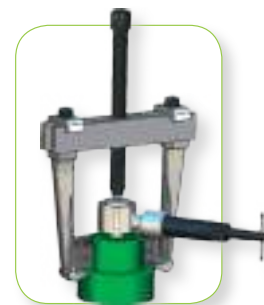
**Martinetto idraulico**

- Dotato di sistema di ritorno
- 2 Alzate
- Capacità: 11 Ton

CODICE	€/Pz
FG 162/MA3	470,00

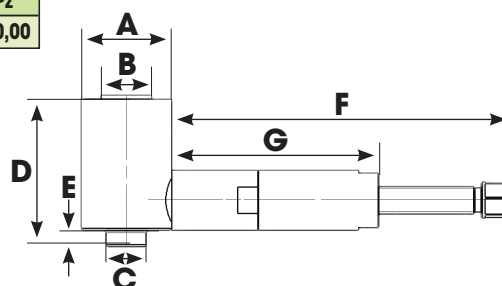
**NEW**

A/mm	B/mm	C/mm	D/mm	E/mm	F/mm	G/mm
70	25	28	82	12	170	103

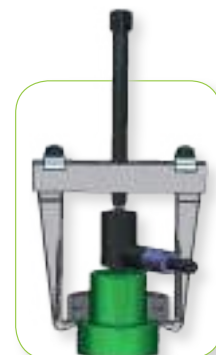



Separatori

CODICE	Ømm	L/mm	€/Pz
FG 166/1	5 - 50	60	63,90
FG 166/2	15 - 110	110	115,40
FG 166/3	15 - 150	150	195,20



Tiranti

CODICE	Ømm	L/mm	€/Pz
FG 167/1	25 - 95	90	56,10
FG 167/2	40 - 120	180	92,30
FG 167/3	75 - 190	245	195,20
FG 167/4	80 - 280	300	316,20

ACCOIPIAMENTI TIRANTE - SEPARATORE	
FG 167/1	-
FG 167/2	FG 166/1
FG 167/3	FG 166/2
FG 167/4	FG 166/3

Espansore a settore per interni



CÓDIGO	A/mm	M	C/mm	€/Pz
FG 182/ES1	8.6-9.6	M10	1.5	41,00
FG 182/ES2	13-18	M10	1.5	50,00
FG 182/ES3	21-23	M10	1.5	53,00
FG 182/ES4	25-29	M10	1.5	54,00
FG 182/ES5	27.2-27.6	M10	2.5	75,00
FG 182/ES6	36.5-37	M10	3.5	84,00
FG 182/ES7	43-51	M16	3.5	102,00

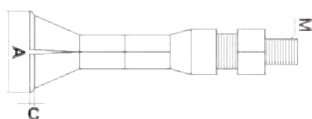

Estrattore per espansore

CODICE	Ø/mm	M	L/mm	€/Pz
FG 182/EG1	35 - 75	M10	140	69,00
FG 182/EG2	60 - 140	M16	160	106,00



Set espansori a settore per interni con accessori

CODICE	CONTENUTO	€/Pz
FG 182/S10	FG 182/ES1 - FG 182/ES7 FG 182/EG1, FG 182/EG2 FG 182/MI	720,00

Estrattore a percussione

CODICE	L/mm	M	€/Pz
FG 182/MI	390	M10	69,00



Set estrattori per cuscinetti con false sfere

- Ømm: 5, 6, 8, 9, 11, 12.5

CODICE	€/Pz
FG 182/S14	195,00



Estrattore a rulli per viti prigioniere

CODICE	M	■ - ◆	L/mm	€/Pz
FG 168/R6	6	1/4" - 21mm	60	10,50
FG 168/R7	7	1/4" - 21mm	60	10,50
FG 168/R8	8	1/4" - 21mm	60	11,00
FG 168/R9	9	1/4" - 21mm	69	11,50
FG 168/R10	10	1/4" - 21mm	69	12,00
FG 168/R10.5	10.5	1/4" - 21mm	69	12,00
FG 168/R12	12	1/4" - 21mm	69	12,50
FG 168/R14	14	- 24mm	73	17,50
FG 168/R16	16	- 24mm	73	18,50



Set 9 strattori a rulli per viti prigioniere

CODICE	CONTENUTO	€/Pz
FG 168/S9	FG 168/R6 - R16	150,00

Estrattore conico per viti e prigionieri spezzati

CODICE	Ø/mm	A/mm	€/Pz
FG 168/F1	3-6	2.5	2,70
FG 168/F2	6-8	3.0	2,70
FG 168/F3	8-11	4.5	3,70
FG 168/F4	11-14	6.0	4,20
FG 168/F5	14-18	8.0	4,70
FG 168/F6	18-24	11.0	6,50
FG 168/F7	24-33	14.0	12,00
FG 168/F8	33-50	21.0	16,50



Set estrattori conici per viti e prigionieri

CODICE	CONTENUTO	€/Pz
FG 168/FS5	FG 168/F1 - F5	16,50
FG 168/FS8	FG 168/F1 - F8	55,00

Set 5 estrattori conici per viti e prigionieri spezzati

- Inserimento a percussione

CODICE	Ø/mm	€/Pz
FG 168EP/S5	3 - 9	26,50

NEW



Set estrattori per viti e prigionieri spezzati

- dotato di guide per interno ed esterno e punte per forare
- per viti/bulloni con diametro 6-16mm

CODICE	€/Pz
FG 168/S25	120,00

NEW

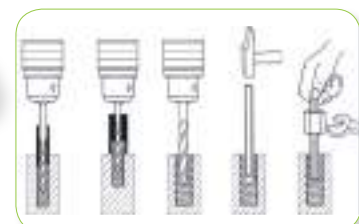

Spaccadadi

CODICE	Ø Max	L/mm	€/Pz
FG 168/SD1	12mm	62	16,00
FG 168/SD2	17mm	82	21,60
FG 168/SD3	22mm	106	29,50
FG 168/SD4	35mm	125	40,70



Set 4 spaccadadi in cassetta di ABS

CODICE	CONTENUTO	€/Pz
FG 168SD/S4	FG 164/SD1 - SD4	123,50

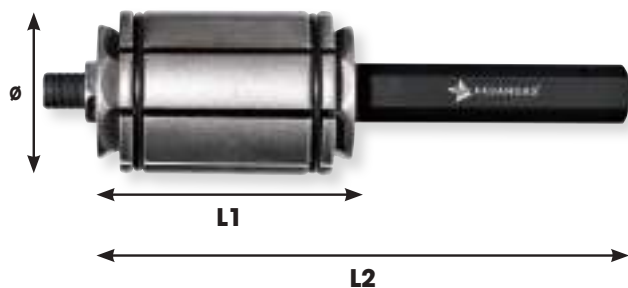

Estrattori ad espansione

CODICE	Ø/mm	L1/mm	L2/mm	€/Pz
FG 182/TS1	29-44	51	132	29,00
FG 182/TS2	38-64	64	164	40,00
FG 182/TS3	54-89	77	215	70,00





10 FEET

3m

3