

02

CHIAVI A BUSSOLA

CHIAVE A BUSSOLA 1/4" ESAGONALE

UTILIZZO:

bulloni esagonali

FINITURA:

cromata lucida

CODICE	mm	A/mm	B/mm	D/mm	E/mm	€/Pz
FG 624/E4	4	6.8	11.6	25.3	8.4	2,90
FG 624/E5	5	7.9	12.0	25.4	9.0	2,90
FG 624/E6	6	9.5	12.0	25.4	11.6	2,90
FG 624/E7	7	10.5	12.0	25.4	11.6	2,90
FG 624/E8	8	12.0	12.0	25.5	11.0	2,90
FG 624/E9	9	12.9	12.9	25.5	10.6	2,90
FG 624/E10	10	14.4	14.4	25.5	12.0	2,90
FG 624/E11	11	15.6	15.6	25.5	11.7	2,90
FG 624/E12	12	16.7	16.7	25.3	11.6	2,90
FG 624/E13	13	17.7	17.7	25.5	11.6	2,90
FG 624/E14	14	17.7	17.7	25.5	11.6	3,00

Set 11 chiavi a bussola esagonali su supporto in plastica

CODICE	Pz	CONTENUTO	€/Pz
FG 624/S11	11	4, 5, 6, 7, 8, 9, 10, 11, 12, 13, 14 mm	38,50

Set 11 chiavi a bussola esagonali e cricchetto su supporto in plastica

CODICE	Pz	CONTENUTO	€/Pz
FG 624/S12	12	4, 5, 6, 7, 8, 9, 10, 11, 12, 13, 14 mm FG 624/CR14	74,00



FG 624/E: 5, 6, 8, 10, 11, 13mm

FG 624/MCR14

FG 89/38PI1 (1/4x1/4)

FG 85/25PH1, PH2, PH3

FG 85/25PZ1, PZ2, PZ3

FG 85/25F3, F5

FG 85/25H4, H5, H6

FG 85/25TX10, TX15, TX20, TX25, TX30, TX40



Set 25 utensili con attacco quadro 1/4"

CODICE	Pz	€/Pz
FG 624/S25A	25	70,00



FG 624/E: 6, 8, 10, 11, 12, 13mm

FG 624/CR14

FG 89/38PI1 (1/4x1/4)

FG 85/25PH1, PH2, PH3

FG 85/25PZ1, PZ2, PZ3

FG 85/25F4, F5, F6, F7

FG 85/25TX10, TX15, TX20, TX25, TX30, TX40



Set 25 utensili con attacco quadro 1/4"

CODICE	Pz	€/Pz
FG 624/S25	18	72,00





Set 18 utensili con attacco quadro 1/4"

CODICE	Pz	€/Pz
FG 624/S18	18	110,00



Set 45 utensili con attacco quadro 1/4"

CODICE	Pz	€/Pz
FG 624/S45	45	170,00

FG 624/E4,5,6,7,8,9,10,11,12,13,14mm

FG 624/CR14

FG 624/ES14
FG 624/PA50, 100
FG 624/PRF150

FG 624/GR14C

FG 624/SN14

FG 624/E4,5,6,7,8,9,10,11,12,13,14mm

FG 624/CR14

FG 624/ES14
FG 624/PA50, 100
FG 624/PRF150

FG 624/SN14

FG 624/GR14C

FG 148/H1.5-H10, FG 148/TX8-TX40
FG 148/PH1-PH4, FG 148/F1-F5

Modulo in gomma 18 utensili da 1/4"

CODICE	Pz	€/Pz
FG 100/17	18	115,00



Modulo rigido 18 utensili da 1/4"

CODICE	Pz	€/Pz
FG 102/17	18	98,00



FG 624/E4,5,6,7,8,9,10,11,12,13,14mm

FG 624/CR14

FG 624/SN14

FG 624/GR14C

FG 624/PA50, 100
FG 624/PRF150
FG 624/ES14

Modulo in gomma 65 utensili da 1/4"

CODICE	Pz	€/Pz
FG 100/17E	65	255,00



Modulo rigido 65 utensili da 1/4"

CODICE	Pz	€/Pz
FG 102/17E	65	240,00



4,5,6,7,8,9,10,11,12,13,14mm

FG 624/CR14

FG 624/PA50, 100
FG 624/PRF150

FG 624/ES14

FG 624/SN14

FG 624/GR14C

FG 147/H2.5-H10
FG 147/PH1-PH4
FG 147/TX9-TX40
FG 147/F1-F5

FG 139/L



CHIAVE A BUSSOLA 1/4" ESAGONALE serie lunga

UTILIZZO

bulloni esagonali

FINITURA

cromata lucida

CODICE	mm	A/mm	B/mm	D/mm	E/mm	€/Pz
FG 624E/L4	4	7.0	12.0	4.0	51.0	6,20
FG 624E/L5	5	8.0	12.0	9.0	51.0	6,20
FG 624E/L6	6	9.0	12.0	11.0	51.0	6,20
FG 624E/L7	7	11.0	12.0	21.0	51.0	6,20
FG 624E/L8	8	11.0	12.0	21.0	51.0	6,60
FG 624E/L9	9	13.0	12.0	21.0	51.0	6,60
FG 624E/L10	10	15.0	15.0	21.0	51.0	6,60
FG 624E/L11	11	15.1	15.0	21.0	51.0	6,60
FG 624E/L12	12	16.8	15.6	21.0	51.0	6,60
FG 624E/L13	13	16.8	15.6	21.0	51.0	6,60
FG 624E/L14	14	19.8	17.7	21.0	51.0	6,60



Set 11 chiavi a bussola esagonali serie lunga

CODICE	Pz	CONTENUTO	€/Pz
FG 624L/S11	11	4, 5, 6, 7, 8, 9, 10, 11, 12, 13, 14 mm	85,00



Set 29 utensili da 1/4"

CODICE	Pz	€/Pz
FG 624/S29	29	175,00



CHIAVE A BUSSOLA 1/4" ESAGONALE in pollici

CODICE	Pollici	A/mm	B/mm	D/mm	E/mm	€/Pz
FG 624A/IN1	5/32	6.8	11.6	25.3	8.4	3,30
FG 624A/IN2	3/16	7.7	12.0	25.4	10.7	3,30
FG 624A/IN3	7/32	8.7	12.0	25.4	10.9	3,30
FG 624A/IN4	1/4	9.5	12.0	25.4	11.6	3,30
FG 624A/IN5	9/32	10.5	12.0	25.4	11.6	3,30
FG 624A/IN6	5/16	12.0	12.0	25.5	11.0	3,30
FG 624A/IN7	11/32	12.9	12.9	25.5	10.6	3,30
FG 624A/IN8	3/8	14.4	14.4	25.5	12.0	3,30
FG 624A/IN9	7/16	15.6	15.6	25.5	11.7	3,30
FG 624A/IN10	15/32	16.7	16.7	25.3	11.6	3,30
FG 624A/IN11	1/2	17.7	17.7	25.5	11.6	3,30
FG 624A/IN12	9/16	17.7	17.7	25.5	11.6	3,30



Set 12 chiavi a bussola esagonali su supporto in plastica

CODICE	Pz	CONTENUTO	€/Pz
FG 624A/INS12	12	5/32, 3/16, 7/32, 1/4, 9/32, 5/16, 11/32, 3/8, 7/16, 15/32, 1/2, 9/16	50,00



CHIAVE A BUSSOLA 1/4" UNIVERSALE

→ UTILIZZO

bulloni Esagonali , Torx,
Quadrati, XZN e Poligonali

→ FINITURA

cromata lucida

CODICE	mm	E	■	B/mm	C/mm	€/Pz
FG 624/U4	4	E5		7.0	9.5	3,30
FG 624/U4.5	4.5			7.5	9.5	3,30
FG 624/U5	5	E6		8.0	9.5	3,30
FG 624/U5.5	5.5			8.8	10.0	3,30
FG 624/U6	6	E8		9.6	10.0	3,30
FG 624/U7	7			10.6	10.0	3,30
FG 624/U8	8	E10		11.6	10.0	3,60
FG 624/U9	9			13.4	11.5	3,60
FG 624/U10	10	E12	8	14.0	11.5	3,60
FG 624/U11	11	E14		15.8	11.5	3,60
FG 624/U12	12	E16	10	16.9	11.5	3,60
FG 624/U13	13	E18	11	18.0	11.5	3,60
FG 624/U14	14		12	20.0	11.5	3,70

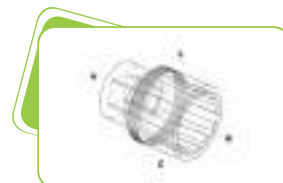

Set 13 chiavi a bussola 1/4" UNIVERSALI

CODICE	Pz	CONTENUTO	€/Pz
FG 624U/S13	13	4, 4.5, 5, 5.5, 6, 7, 8, 9, 10, 11, 12, 13, 14mm	56,00



CHIAVE A BUSSOLA 1/4" TORX

→ UTILIZZO

bulloni Torx

→ FINITURA

cromata lucida

CODICE	E	A/mm	B/mm	L/mm	€/Pz
FG 624/TX4	4	11.8	6.8	25.0	5,00
FG 624/TX5	5	11.8	8.0	25.0	5,00
FG 624/TX6	6	11.8	9.3	25.0	5,00
FG 624/TX7	7	11.8	10.6	25.0	5,00
FG 624/TX8	8	11.8	11.8	25.0	5,00
FG 624/TX10	10	11.8	11.8	25.0	5,00



Set 6 chiavi a bussola 1/4" Torx

CODICE	Pz	CONTENUTO	€/Pz
FG 624TX/S6	6	4, 5, 6, 7, 8, 10 E	40,00



Set 6 chiavi a bussola TX + 8 inserti a bussola TX e accessori

CODICE	CONTENUTO	€/Pz
FG 624TX/S17	BUSSOLE TX4, TX5, TX6, TX7, TX8, TX10 INSERTI A BUSSOLA TX9, TX10, TX15, TX20, TX25, TX27, TX30, TX40 PROLUNGA 1/4" - 100mm SNODO 1/4" + QUADRO MASCHIO 1/4"	78,00





Inserto a bussola 1/4" con impronta Torx

CODICE	TX	L/mm	€/Pz
FG 147/TX9	9	36.0	7,40
FG 147/TX10	10	36.0	7,40
FG 147/TX15	15	36.0	7,40
FG 147/TX20	20	36.0	7,40



CODICE	TX	L/mm	€/Pz
FG 147/TX25	25	36.0	7,40
FG 147/TX27	27	36.0	7,40
FG 147/TX30	30	36.0	7,40
FG 147/TX40	40	36.0	7,40

Set 8 inserti a bussola Torx 1/4"

CODICE	Pz	CONTENUTO	€/Pz
FG 147TX/S8	8	TX9, 10, 15, 20, 25, 27, 30, 40	65,00

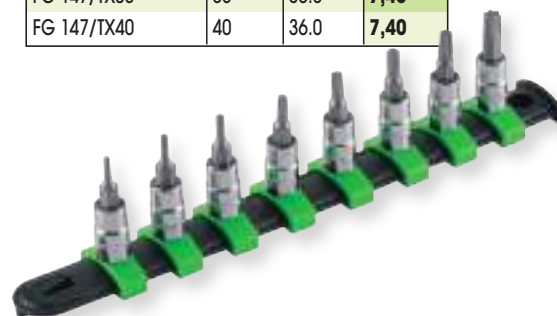

Inserto a bussola 1/4" pentalombato

CODICE	PH	L/mm	€/Pz
FG 147/PT10	10	36.0	8,50
FG 147/PT15	15	36.0	8,50
FG 147/PT20	20	36.0	8,50



CODICE	PH	L/mm	€/Pz
FG 147/PT25	25	36.0	8,50
FG 147/PT27	30	36.0	8,50
FG 147/PT30	25	36.0	8,50

Set 6 inserti a bussola pentalombati da 1/4"

CODICE	Pz	CONTENUTO	€/Pz
FG 147PT/S6	6	PT10, 15, 20, 25, 27, 30	58,00

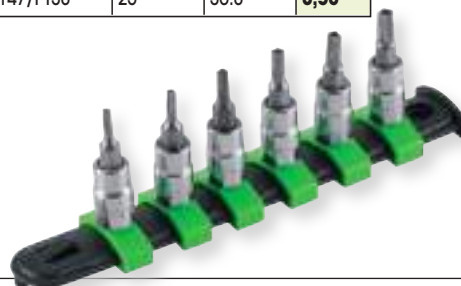

Inserto a bussola 1/4" esagonale

CODICE	mm	L/mm	€/Pz
FG 147/H2.5	2.5	36.0	5,40
FG 147/H3	3	36.0	5,40
FG 147/H4	4	36.0	5,40
FG 147/H5	5	36.0	5,40



CODICE	mm	L/mm	€/Pz
FG 147/H6	6	36.0	5,40
FG 147/H7	7	36.0	5,40
FG 147/H8	8	36.0	5,40
FG 147/H10	10	36.0	5,40

Set 8 inserti a bussola 1/4" per viti con impronta esagonale

CODICE	Pz	CONTENUTO	€/Pz
FG 147H/S8	8	2.5, 3,4,5,6,7,8,10	52,00

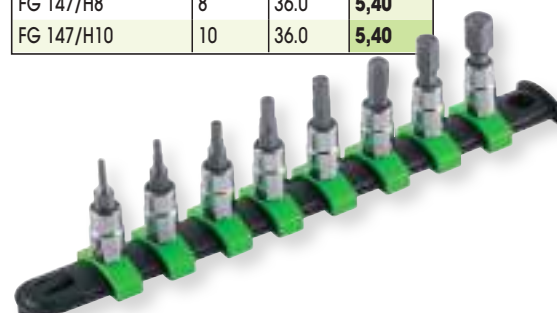

Inserto a bussola 1/4" a croce PH



CODICE	PH	L/mm	€/Pz
FG 147/PH1	1	36.0	5,40
FG 147/PH2	2	36.0	5,40
FG 147/PH3	3	36.0	5,40
FG 147/PH4	4	36.0	5,40



Inserto a bussola 1/4" ad intaglio



CODICE	mm	L/mm	€/Pz
FG 147/SL4	0.8x4.0	36.0	5,40
FG 147/SL5.5	1.0x5.5	36.0	5,40
FG 147/SL6.5	1.2x6.5	36.0	5,40
FG 147/SL8	1.6x8.0	36.0	5,40
FG 147/SL10	1.6x10.0	36.0	5,40



Cricchetto reversibile 1/4" a 72 denti

CODICE	■	€/Pz
FG 624/CR14	1/4"	32,50

- Sistema di inversione a ghiera integrato sulla testa
- Meccanismo a 72 denti
- Cromatura lucida
- Asola di aggancio

Cricchetto reversibile 1/4" con impugnatura rotante - 60 denti

CODICE	■	€/Pz
FG 624/RT14	1/4"	50,00



Mini-cricchetto con attacco quadro 1/4" a 72 denti

CODICE	■	€/Pz
FG 624/MCR	1/4"	30,00



Mini-cricchetto con attacco esagonale per inserti 1/4"

CODICE	□	€/Pz
FG 624/MCH	1/4"	30,00



Cricchetto reversibile 1/4" a 72 denti

CODICE	■	€/Pz
FG 624/FR14	1/4"	35,00

NEW



Quadro maschio 1/4" snodato con impugnatura

CODICE	L/mm	€/Pz
FG 624/CS14	160	24,30



- Modello con testa chiusa anti polvere
- Leva di inversione integrata a filo testa
- Corpo scavato di 13° per consentire l'utilizzo anche in spazi particolarmente difficoltosi
- Meccanismo a 72 denti
- Cromatura lucida
- Asola di aggancio



Prolunga con attacco quadro maschio e femmina 1/4" ed estremità angolari

CODICE	L/mm	€/Pz
FG 624/PA50	50	6,50
FG 624/PA100	100	6,90

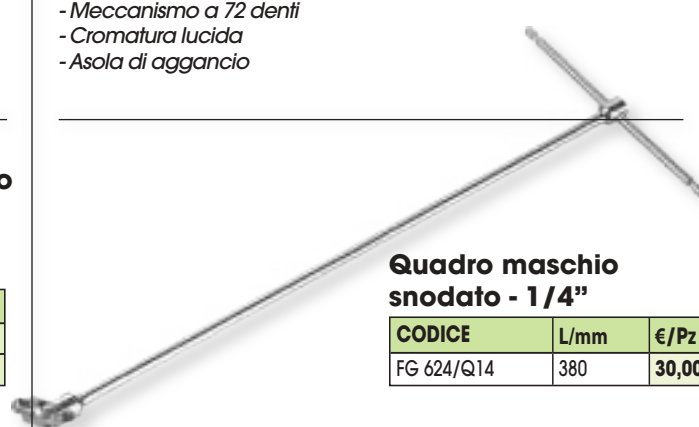

Quadro maschio snodato - 1/4"

CODICE	L/mm	€/Pz
FG 624/Q14	380	30,00



Prolunga attacco quadro maschio e femmina 1/4"

CODICE	L/mm	€/Pz
FG 624/PR50	50	5,60
FG 624/PR100	100	6,10
FG 624/PR150	150	6,70



Quadro maschio con impugnatura - attacco 1/4"

CODICE	L/mm	€/Pz
FG 624/ES14	115	6,00



Prolunga attacco quadro maschio e femmina 1/4" - flessibile

CODICE	L/mm	€/Pz
FG 624/PRF150	150	10,40



CODICE		L/mm	€/Pz
FG 624/GR14B	Asta flessibile	291.6	14,00
FG 624/GR14C	Asta NO flex	246.6	9,00



Snodo con attacco quadro maschio e femmina 1/4"

CODICE	L/mm	€/Pz
FG 624/SN14	38	13,90



CHIAVE A BUSSOLA 3/8" ESAGONALE

UTILIZZO

bulloni esagonali

FINITURA

cromata lucida

CODICE	mm	A/mm	B/mm	D/mm	E/mm	€/Pz
FG 624/B8	8	12.2	20.0	32.0	5.0	5,10
FG 624/B9	9	13.5	20.0	32.0	5.0	5,10
FG 624/B10	10	14.7	20.0	32.0	6.0	5,10
FG 624/B11	11	16.0	20.0	32.0	7.0	5,10
FG 624/B12	12	17.2	20.0	32.0	8.0	5,10
FG 624/B13	13	18.5	20.0	32.0	8.0	5,10
FG 624/B14	14	19.8	20.0	32.0	10.0	5,30
FG 624/B15	15	21.0	21.0	35.0	10.0	5,30
FG 624/B16	16	22.2	23.0	35.0	10.0	5,50
FG 624/B17	17	23.8	24.0	35.0	10.0	5,50
FG 624/B18	18	24.8	24.0	35.0	12.0	5,50
FG 624/B19	19	26.0	24.0	35.0	12.0	6,50
FG 624/B21	21	28.5	27.0	35.0	12.0	6,50
FG 624/B22	22	29.7	28.0	38.0	14.0	6,50
FG 624/B23	23	31.5	28.8	38.0	14.0	6,50

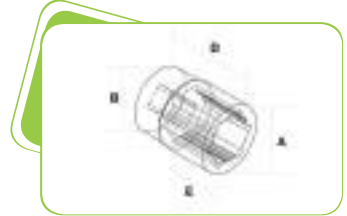

Set 15 chiavi a bussola esagonali da 3/8"

CODICE	Pz	CONTENUTO	€/Pz
FG 624B/S15	15	8, 9, 10, 11, 12, 13, 14, 15, 16, 17, 18, 19, 21, 22, 23mm	104,00

Set 15 chiavi a bussola esagonali 3/8" e cricchetto

CODICE	Pz	CONTENUTO	€/Pz
FG 624B/S16	16	8, 9, 10, 11, 12, 13, 14, 15, 16, 17, 18, 19, 21, 22, 23mm FG 624/CR38	140,00



Set 22 utensili con attacco quadro 3/8"

CODICE	Pz	€/Pz
FG 624B/S22	22	205,00



FG 624/B8,9,10,11,12,13,14,15
16,17,18,19,21,22,23mm

FG 624/CR38

FG 624B/PA75,125,150,250

FG 624/ES38

FG 624/SN38

Modulo in gomma 22 utensili da 3/8"

CODICE	Pz	€/Pz
FG 100/19	22	200,00



Modulo rigido 22 utensili da 3/8"

CODICE	Pz	€/Pz
FG 102/19	22	180,00



FG 624/B8,9,10,11,12,13,14,15
16,17,18,19,21,22,23mm

FG 624/CR38

FG 624B/PA75,100,125,250

FG 624/ES38

FG 624/SN38

CHIAVE A BUSSOLA 3/8" ESAGONALE - serie lunga

UTILIZZO

bulloni esagonali

FINITURA

cromata lucida



CODICE	mm	A/mm	B/mm	D/mm	E/mm	€/Pz
FG 624B/L8	8	12.2	17.5	7.1	54.0	9,30
FG 624B/L9	9	13.2	17.5	7.1	54.0	9,30
FG 624B/L10	10	14.8	17.5	7.9	54.0	9,30
FG 624B/L11	11	16.2	17.5	9.7	54.0	9,30
FG 624B/L12	12	17.5	17.5	9.9	54.0	9,30
FG 624B/L13	13	17.8	17.8	10.7	54.0	9,30
FG 624B/L14	14	19.8	18.6	10.7	61.0	9,30
FG 624B/L15	15	20.3	19.5	10.7	61.0	10,50
FG 624B/L16	16	21.8	20.2	10.7	61.0	10,50
FG 624B/L17	17	23.8	21.8	11.2	67.0	10,50
FG 624B/L18	18	24.8	23.5	11.2	67.0	10,50
FG 624B/L19	19	25.8	24.0	12.2	67.9	10,50
FG 624B/L21	21	27.8	26.4	12.4	67.0	12,30
FG 624B/L22	22	29.8	27.2	13.0	73.0	12,30
FG 624B/L23	23	31.5	28.8	13.2	73.0	12,30

Set 15 chiavi a bussola esagonali da 3/8"

CODICE	Pz	CONTENUTO	€/Pz
FG 624L/S15	15	8, 9, 10, 11, 12, 13, 14, 15, 16, 17, 18, 19, 21, 22, 23mm	160,00

Set 15 chiavi a bussola esagonali e cricchetto da 3/8"

CODICE	Pz	CONTENUTO	€/Pz
FG 624L/S16	16	8, 9, 10, 11, 12, 13, 14, 15, 16, 17, 18, 19, 21, 22, 23mm FG 624/CR38	195,00

Set 20 utensili con attacco quadro 3/8"

CODICE	Pz	€/Pz
FG 624B/LS20	20	282,00



- FG 624B/L8,9,10,11,12,13,14,15
16,17,18,19,21,22,23mm
- FG 624/CR38
- FG 624B/PA75,125,150,250
- FG 624/ES38
- FG 624/SN38

Modulo in gomma 20 utensili da 3/8"

CODICE	Pz	€/Pz
FG 100/18	20	271,00



- FG 624B/L8,9,10,11,12,13,14,15
16,17,18,19,21,22,23mm
- FG 624/CR38
- FG 624B/PA75,100,125,250
- FG 624/ES38
- FG 624/SN38



CHIAVE A BUSSOLA 3/8" POLIGONALE

→ UTILIZZO

bulloni esagonali e poligonali

→ FINITURA

cromata lucida

CODICE	mm	A/mm	B/mm	D/mm	E/mm	€/Pz
FG 624/C6	6	12.2	20.0	32.0	5.0	4,10
FG 624/C7	7	13.5	20.0	32.0	5.0	4,10
FG 624/C8	8	12.2	20.0	32.0	5.0	4,20
FG 624/C9	9	13.5	20.0	32.0	5.0	4,20
FG 624/C10	10	14.7	20.0	32.0	6.0	4,20
FG 624/C11	11	16.0	20.0	32.0	7.0	4,20
FG 624/C12	12	17.2	20.0	32.0	8.0	4,20
FG 624/C13	13	18.5	20.0	32.0	8.0	4,20
FG 624/C14	14	19.8	20.0	32.0	10.0	4,30
FG 624/C15	15	21.0	21.0	35.0	10.0	4,40
FG 624/C16	16	22.2	23.0	35.0	10.0	4,40
FG 624/C17	17	23.8	24.0	35.0	10.0	4,50
FG 624/C18	18	24.8	24.0	35.0	12.0	4,60
FG 624/C19	19	26.0	24.0	35.0	12.0	4,70
FG 624/C20	20	26.0	24.0	35.0	12.0	4,70
FG 624/C21	21	28.5	27.0	35.0	12.0	4,70
FG 624/C22	22	29.7	28.0	38.0	14.0	4,80
FG 624/C24	24	31.5	28.8	38.0	14.0	5,60

Set 18 chiavi a bussola poligonali da 3/8"

CODICE	Pz	CONTENUTO	€/Pz
FG 624C/S18	18	6, 7, 8, 9, 10, 11, 12, 13, 14, 15, 16, 17, 18, 19, 20, 21, 22, 24mm	88,00



Set 22 utensili con attacco quadro 3/8"

CODICE	Pz	€/Pz
FG 624C/S22	22	186,00



FG 624/C8,9,10,11,12,13,14,
15,16,17,18,19, 21mm

FG 624/CR38

FG 624B/PA75,125,150,250

FG 624/ES38

FG 624/SN38

Modulo in gomma 22 utensili da 3/8"

CODICE	Pz	€/Pz
FG 100/19B	22	180,00



Modulo rigido 22 utensili da 3/8"

CODICE	Pz	€/Pz
FG 102/19B	22	160,00



FG 624/C8,9,10,11,12,13,14,
15,16,17,18,19,21mm

FG 624/CR38

FG 624B/PA75,100,125,250

FG 624/ES38

FG 624/SN38

CHIAVE A BUSSOLA 3/8" POLIGONALI -serie lunga

→ UTILIZZO

bulloni esagonali e poligonali

→ FINITURA

cromata lucida

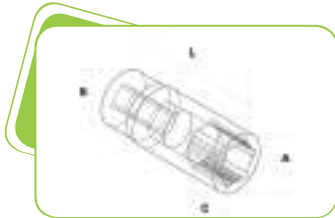

CODICE	mm	A/mm	B/mm	D/mm	E/mm	€/Pz
FG 624/L6	6	12.2	17.5	7.1	54.0	7,10
FG 624/L7	7	13.2	17.5	7.1	54.0	7,10
FG 624/L8	8	12.2	17.5	7.1	54.0	7,10
FG 624/L9	9	13.2	17.5	7.1	54.0	7,10
FG 624/L10	10	14.8	17.5	7.9	54.0	7,10
FG 624/L11	11	16.2	17.5	9.7	54.0	7,10
FG 624/L12	12	17.5	17.5	9.9	54.0	7,10
FG 624/L13	13	17.8	17.8	10.7	54.0	7,30
FG 624/L14	14	19.8	18.6	10.7	61.0	7,90
FG 624/L15	15	20.3	19.5	10.7	61.0	9,30
FG 624/L16	16	21.8	20.2	10.7	61.0	9,30
FG 624/L17	17	23.8	21.8	11.2	67.0	10,00
FG 624/L18	18	24.8	23.5	11.2	67.0	10,40
FG 624/L19	19	25.8	24.0	12.2	67.9	10,40
FG 624/L20	20	26.0	26.4	12.4	67.0	10,90
FG 624/L21	21	27.8	26.4	12.4	67.0	10,90
FG 624/L22	22	29.8	27.2	13.0	73.0	11,40
FG 624/L24	24	31.5	28.8	13.2	73.0	11,90

Set 18 chiavi a bussola poligonali da 3/8"

CODICE	Pz	CONTENUTO	€/Pz
FG 624L/S18	18	6, 7, 8, 9, 10, 11, 12, 13, 14, 15, 16, 17, 18, 19, 20, 21, 22, 24mm	180,00

Set 20 utensili con attacco quadro 3/8"

CODICE	Pz	€/Pz
FG 624L/S20	20	236,90



- FG 624/L8,9,10,11,12,13,14, 15, 16,17,18,19,21mm
- FG 624/CR38
- FG 624B/PA75,125,150,250
- FG 624/ES38
- FG 624/SN38

Modulo in gomma 20 utensili da 3/8"

CODICE	Pz	€/Pz
FG 100/18B	20	225,00

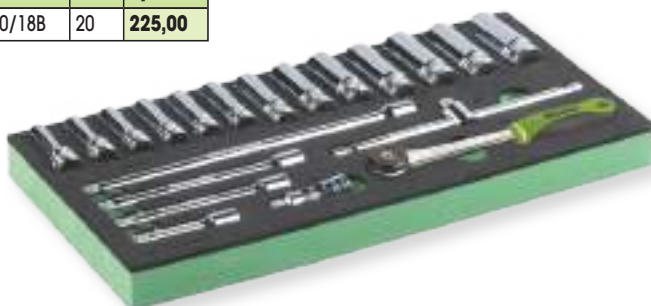

- FG 624/L8,9,10,11,12,13,14, 15, 16,17,18,19,21mm
- FG 624/CR38
- FG 624B/PA75,100,125,250
- FG 624/ES38
- FG 624/SN38



CHIAVE A BUSSOLA 3/8" POLIGONALE in pollici

UTILIZZO

bulloni in pollici

FINITURA

cromata lucida

CODICE	"	A/mm	B/mm	D/mm	E/mm	€/Pz
FG 624C/IN1	1/4	12.2	20.0	32.0	5.0	4,90
FG 624C/IN2	5/16	12.2	20.0	32.0	5.0	4,90
FG 624C/IN3	11/32	13.5	20.0	32.0	5.0	4,90
FG 624C/IN4	3/8	14.7	20.0	32.0	6.0	4,90
FG 624C/IN5	7/16	16.0	20.0	32.0	7.0	4,90
FG 624C/IN6	15/32	17.2	20.0	32.0	8.0	5,40
FG 624C/IN7	1/2	18.5	20.0	32.0	8.0	5,40
FG 624C/IN8	9/16	19.8	20.0	32.0	10.0	5,40
FG 624C/IN9	19/32	21.0	21.0	35.0	10.0	5,90
FG 624C/IN10	5/8	22.2	23.0	35.0	10.0	5,90
FG 624C/IN11	11/16	23.8	24.0	35.0	10.0	5,90
FG 624C/IN12	3/4	26.0	24.0	35.0	12.0	6,40
FG 624C/IN13	25/32	26.0	24.0	35.0	12.0	6,40
FG 624C/IN14	13/16	28.5	27.0	35.0	12.0	6,90
FG 624C/IN15	7/8	29.7	28.0	38.0	14.0	7,40
FG 624C/IN16	15/16	31.5	28.8	38.0	14.0	7,90

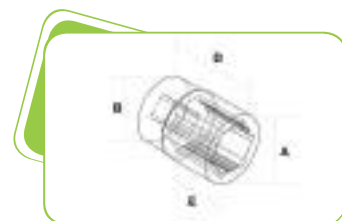

Set 13 chiavi a bussola poligonali in pollici da 3/8"

CODICE	Pz	CONTENUTO	€/Pz
FG 624C/INS13	13	1/4, 5/16, 11/32, 3/8, 7/16, 1/2, 9/16, 19/32, 5/8, 11/16, 3/4, 13/16, 7/8	82,00



Set 23 utensili con attacco quadro 3/8"

CODICE	Pz	€/Pz
FG 624C/INS23	23	211,00



1/4, 5/16, 11/32, 3/8, 7/16, 15/32, 1/2, 9/16, 19/32, 5/8, 11/16, 3/4, 25/32, 13/16, 7/8, 15/16

FG 624/CR38

FG 624B/PA75,150,125,250

FG 624/ES38

FG 624/SN38

Modulo in gomma 23 utensili da 3/8"

CODICE	Pz	€/Pz
FG 100/19IN	23	201,00



1/4, 5/16, 11/32, 3/8, 7/16, 15/32, 1/2, 9/16, 19/32, 5/8, 11/16, 3/4, 25/32, 13/16, 7/8, 15/16

FG 624/CR38

FG 624B/PA75,150,125,250

FG 624/ES38

FG 624/SN38

CHIAVE A BUSSOLA 3/8" TORX

→ **UTILIZZO**

bulloni con impronta Torx

→ **FINITURA**

cromata lucida

CODICE	mm	A/mm	B/mm	E/mm	L/mm	€/Pz
FG 624B/TX5	5	16.8	9.3	10.5	28.0	5,90
FG 624B/TX6	6	16.8	9.3	10.5	28.0	5,90
FG 624B/TX7	7	16.9	11.7	10.7	28.0	5,90
FG 624B/TX8	8	16.9	11.7	10.7	28.0	5,90
FG 624B/TX10	10	16.9	14.5	10.8	28.0	5,90
FG 624B/TX12	12	19.8	17.0	14.0	32.0	5,90
FG 624B/TX14	14	19.8	17.5	14.0	32.0	5,90
FG 624B/TX16	16	19.8	17.0	14.0	32.0	5,90

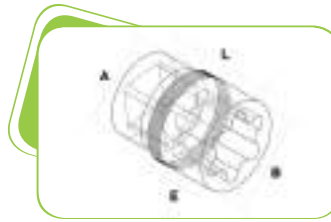

Set 8 chiavi a bussola 3/8" Torx su supporto plastica

CODICE	Pz	CONTENUTO	€/Pz
FG 624TX/S8	8	5, 6, 7, 8, 10, 12, 14, 16 E	53,00

CHIAVE A BUSSOLA 3/8" TORX serie lunga

→ **UTILIZZO**

bulloni con impronta Torx

→ **FINITURA**

cromata lucida Super-Bright

CODICE	mm	A/mm	B/mm	L/mm	€/Pz
FG 624L/TX6	6	16.8	10.0	63.0	9,40
FG 624L/TX7	7	16.8	10.9	63.0	9,40
FG 624L/TX8	8	16.8	12.0	63.0	9,40
FG 624L/TX10	10	16.8	14.9	63.0	9,40
FG 624L/TX12	12	16.8	15.8	63.0	9,40
FG 624L/TX14	14	16.8	16.8	63.0	9,40
FG 624L/TX16	16	17.8	17.8	63.0	9,40
FG 624L/TX18	18	17.8	19.8	63.0	9,40

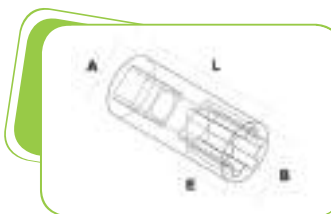

Set 8 chiavi a bussola 3/8" Torx su supporto plastica

CODICE	Pz	CONTENUTO	€/Pz
FG 624L/TXS8	8	6, 7, 8, 10, 12, 14, 16, 18 E	82,00

Set 10 chiavi a bussola EXTRA-LUNGHE con impronta TORX - attacco quadro 3/8"

- *Contenuto:*

E6, E7, E8, E10, E11, E12, E14, E16, E18, E20

CODICE	Pz	€/Pz
FG 624B/TXS10	10	125,00





Inserto a bussola 3/8" con impronta Torx

CODICE	TX	L/mm	€/Pz
FG 149/TX9	9	50.0	9,40
FG 149/TX10	10	50.0	9,40
FG 149/TX15	15	50.0	9,40
FG 149/TX20	20	50.0	9,40

CODICE	TX	L/mm	€/Pz
FG 149/TX25	25	50.0	9,40
FG 149/TX27	27	50.0	9,40
FG 149/TX30	30	50.0	9,40
FG 149/TX40	40	50.0	9,40



Set 8 inserti a bussola Torx 3/8"

CODICE	Pz	CONTENUTO	€/Pz
FG 149TX/S8	8	TX9, 10, 15, 20, 25, 27, 30, 40	67,00

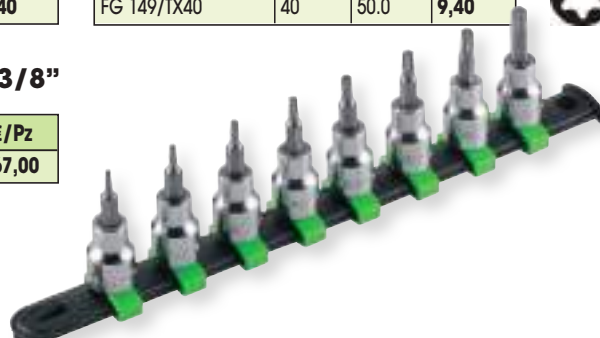

Set 8 inserti a bussola Torx 3/8" in cassetta di ABS

CODICE	Pz	CONTENUTO	€/Pz
FG 149TX/S8B	8	TX9, 10, 15, 20, 25, 27, 30, 40	82,00



Inserto a bussola 3/8" esagonale

CODICE	mm	L/mm	€/Pz
FG 149/H3	3	50.0	5,90
FG 149/H4	4	50.0	5,90
FG 149/H5	5	50.0	5,90
FG 149/H6	6	50.0	5,90



CODICE	mm	L/mm	€/Pz
FG 149/H7	7	50.0	5,90
FG 149/H8	8	50.0	5,90
FG 149/H10	10	50.0	5,70

Set 7 inserti a bussola 3/8" per viti con impronta esagonale

CODICE	Pz	CONTENUTO	€/Pz
FG 149H/S7	7	3,4,5,6,7,8,10	45,00



Inserto a bussola 3/8" pentalombato



CODICE	PT	L/mm	€/Pz
FG 149/PT40	40	50.0	8,50
FG 149/PT45	45	50.0	8,50
FG 149/PT50	50	50.0	8,50



Inserto a bussola 3/8" ad intaglio



CODICE	mm	L/mm	€/Pz
FG 149/SL5.5	1.0x5.5	50.0	5,90
FG 149/SL6.5	1.2x6.5	50.0	5,90
FG 149/SL8	1.6x8.0	50.0	5,90
FG 149/SL10	1.6x10.0	50.0	5,90

Inserto a bussola 3/8" a croce PH



CODICE	PH	L/mm	€/Pz
FG 149/PH1	1	50.0	5,90
FG 149/PH2	2	50.0	5,90
FG 149/PH3	3	50.0	5,90
FG 149/PH4	4	50.0	5,90

Set 8 inserti a bussola 3/8"

CODICE	Pz	€/Pz
FG 149PF/S8	8	50,00





Cricchetto reversibile 3/8" a 72 denti

CODICE	■	€/Pz
FG 624/CR38	3/8"	35,00

- Sistema di inversione a ghiera integrato sulla testa
- Meccanismo a 72 denti
- Cromatura lucida
- Asola di aggancio

Quadro maschio 3/8" snodato con impugnatura

CODICE	L/mm	€/Pz
FG 624/CS38	260	30,00

Quadro maschio snodato con attacco 3/8"

CODICE	L/mm	€/Pz
FG 624/Q38	425	31,00



Snodo con attacco quadro maschio e femmina 3/8"

CODICE	L/mm	€/Pz
FG 624/SN38	52	12,00

Quadro maschio 3/8" con impugnatura

CODICE	L/mm	€/Pz
FG 624/ES38	220	12,00

Prolunga con quadro maschio e femmina 3/8" - estremità angolari

CODICE	L/mm	€/Pz
FG 624B/PA75	75	8,80
FG 624B/PA125	125	9,30
FG 624B/PA150	150	12,40
FG 624B/PA250	250	17,00

Set 80 utensili con attacco quadro 3/8"

CODICE	CONTENUTO	€/Pz
FG 624B/S80	80pz	220,00



	FG 624/B8,9,10,11,12,13,14,15,16,17,18,19,21,22,23
	FG 624B/L8,10,13,17,19
	FG 624/CR38
	FG 625/SN38
	FG 149/H3,4,5,6,7,8, 10 FG 149/TX9,10,15,20,25,27,30,40
	FG 624/ES38
	FG 624B/PA75,125,150,250
	FG 600/B8,10,13,15,17,19
	FG 89/50PI2 3/8"x1/4"
	FG 85/25PH1, PH2, PH3, FG 85/25PZ1, PZ2, PZ3 FG 85/25SL3, SL4, SL4.5, SL5, SL5.5, SL6, L6.5 FG 85/H1.5, H2, 2.5, H3, H4, H5, H6 FG 85/25T9, T10, T15, T20, T25, T27, T30, T40 FG 88/60PI2



CHIAVE A BUSSOLA 1/2" ESAGONALE

UTILIZZO

bulloni esagonali

FINITURA

cromata lucida

CODICE	mm	A/mm	B/mm	D/mm	E/mm	€/Pz
FG 625/A8	8	14.9	21.8	38.1	7.5	4,50
FG 625/A9	9	16.5	21.8	38.1	8.0	4,50
FG 625/A10	10	14.9	21.8	38.1	7.5	4,50
FG 625/A11	11	16.5	21.8	38.1	8.0	4,50
FG 625/A12	12	18.2	21.8	38.1	9.1	4,50
FG 625/A13	13	19.0	21.8	38.1	9.1	4,50
FG 625/A14	14	20.5	21.8	38.1	10.7	4,50
FG 625/A15	15	22.2	22.6	38.1	10.7	4,50
FG 625/A16	16	23.8	22.6	38.1	10.7	4,50
FG 625/A17	17	24.5	22.9	38.1	12.7	4,50
FG 625/A18	18	25.4	23.7	38.1	13.9	5,30
FG 625/A19	19	26.3	24.8	38.1	14.0	5,30
FG 625/A20	20	27.1	26.1	38.1	14.0	5,80

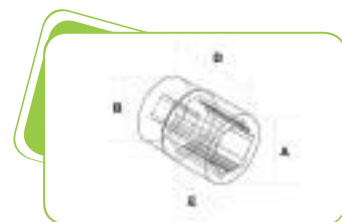

CODICE	mm	A/mm	B/mm	D/mm	E/mm	€/Pz
FG 625/A21	21	28.3	27.5	38.1	14.0	5,80
FG 625/A22	22	29.9	28.6	38.1	14.2	7,20
FG 625/A23	23	31.2	29.9	38.1	14.5	7,80
FG 625/A24	24	32.5	31.0	38.1	15.5	7,80
FG 625/A25	25	33.3	32.6	38.1	15.5	7,80
FG 625/A26	26	34.6	33.4	41.3	16.0	7,90
FG 625/A27	27	36.5	34.9	44.5	19.6	7,90
FG 625/A30	30	41.0	39.6	44.5	19.6	8,00
FG 625/A32	32	42.5	41.2	47.6	19.6	8,30

Set chiavi a bussola esagonali da 1/2"

CODICE	Pz	CONTENUTO	€/Pz
FG 625A/S11	11	8,10,11,12,13,14,15,16,17,18,19	65,00
FG 625A/S10	10	20,21,22,23,24,25,26,27,30,32	82,00

Set 11 chiavi a bussola esagonali e cricchetto su supporto in plastica

CODICE	Pz	CONTENUTO	€/Pz
FG 625A/S12	12	8,10,11,12,13,14,15,16,17,18,19 + FG 625/CR12	110,00



Set 25 utensili con attacco quadro 1/2"

CODICE	Pz	€/Pz
FG 625A/S25	25	230,00

FG 625/A10,11,12,13,14,15,16,17,18,19,20,21,22, 23,24,25,26,27,30,32mm

FG 625/CR12

FG 625/PA125, 250

FG 625/ES12

FG 625/SN12



Modulo in gomma 25 utensili da 1/2"

CODICE	Pz	€/Pz
FG 100/21B	25	220,00



Modulo rigido 25 utensili da 1/2"

CODICE	Pz	€/Pz
FG 102/21B	25	202,00



FG 625/A10,11,12,13,14,15,16,17,18,19,20,21,22, 23,24,25,26,27,30,32mm

FG 625/CR12

FG 625/PA125, 250

FG 625/ES12

FG 625/SN12



CHIAVE A BUSSOLA 1/2" ESAGONALE - serie lunga

- **UTILIZZO**

bulloni esagonali

- **FINITURA**

cromata lucida



CODICE	mm	A/mm	B/mm	C/mm	L/mm	€/Pz
FG 625L/A10	10	15.4	22,0	20,0	76.8	11,30
FG 625L/A11	11	16.4	22,0	18,0	77,0	11,30
FG 625L/A12	12	18,0	22,0	20,0	76.8	11,30
FG625L/A13	13	19,0	22,0	19.4	77,0	11,30
FG 625L/A14	14	20.4	22,0	32.7	77,0	11,30
FG 625L/A15	15	21.9	20.9	34,0	76.3	11,30
FG 625L/A16	16	22,0	20.3	31.8	76.7	11,60
FG 625L/A17	17	24,0	22,0	31.5	77,0	11,60
FG 625L/A18	18	26,0	23,0	35.8	77.4	11,60
FG 625L/A19	19	26,0	24,0	31,0	77,0	11,60
FG 625L/A20	20	27.7	26.5	23,0	79.7	13,00
FG 625L/A21	21	27.8	26,0	31.7	77,0	13,00
FG 625L/A22	22	29.8	26,0	33,0	77,0	14,30
FG 625L/A23	23	31.5	28.8	23.6	72.9	16,30
FG 625L/A24	24	31.8	28,0	33,0	77,0	17,00
FG 625L/A25	25	33.2	31.7	23.4	80.2	17,00
FG 625L/A26	26	35,0	33.2	24,0	80.2	17,00
FG 625L/A27	27	35.8	31,0	31.5	77.1	19,20
FG 625L/A28	28	37.5	35.6	24,0	80.2	22,00
FG 625L/A29	29	37.8	34,0	31.4	77,0	22,00
FG 625L/A30	30	39.7	34,0	31.7	77,0	22,50
FG 625L/A32	32	43,0	40.9	27.3	80,0	22,50
FG 625L/A36	36	48,0	40,0	35,0	78,0	39,50

Set chiavi a bussola esagonali da 1/2"

CODICE	Pz	CONTENUTO	€/Pz
FG 625AL/S11	11	10,12,13,14,15,16,17,18,19,21,22mm	125,00
FG 625AL/S9	9	23,24,25,26,27,28,29,30,32	184,00

Set 37 utensili con attacco quadro 1/2"

CODICE	Pz	€/Pz
FG 625A/S37	37	410,00



FG 625/A8, 9, 10,11,12,13, 14,15,16,17, 18,19,20,21,22,23, 24,26, 27,30,32mm



FG 625L/A10,12,13,14,17,19,21, 22,24,27,30mm



FG 625/CR12



FG 625/PA125, 250



FG 625/ES12



FG 625/SN12

Modulo 37 utensili con attacco quadro 1/2"

CODICE	Pz	€/Pz
FG 100/21H	37	385,00



FG 625/A8, 9, 10,11,12,13, 14,15,16,17, 18,19,20,21,22,23, 24,26, 27,30,32mm



FG 625L/A10,12,13,14,17,19,21, 22,24,27,30mm



FG 625/CR12



FG 625/PA125, 250



FG 625/ES12



FG 625/SN12



CHIAVE A BUSSOLA 1/2" POLIGONALE

UTILIZZO

bulloni esagonali e poligonali

FINITURA

cromata lucida

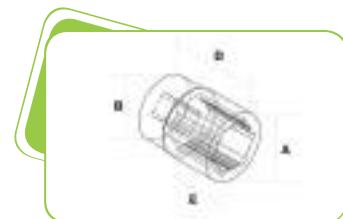

CODICE	mm	C/mm	B/mm	D/mm	E/mm	€/Pz
FG 625/C8	8	14.9	21.8	38.1	7.5	4,50
FG 625/C9	9	16.5	21.8	38.1	8.0	4,50
FG 625/C10	10	14.9	21.8	38.1	7.5	4,50
FG 625/C11	11	16.5	21.8	38.1	8.0	4,50
FG 625/C12	12	18.2	21.8	38.1	9.1	4,50
FG 625/C13	13	19.0	21.8	38.1	9.1	4,50
FG 625/C14	14	20.5	21.8	38.1	10.7	4,50
FG 625/C15	15	22.2	22.6	38.1	10.7	4,50
FG 625/C16	16	23.8	22.6	38.1	10.7	4,50
FG 625/C17	17	24.5	22.9	38.1	12.7	4,50
FG 625/C18	18	25.4	23.7	38.1	13.9	5,30
FG 625/C19	19	26.3	24.8	38.1	14.0	5,30
FG 625/C20	20	27.1	26.1	38.1	14.0	5,80

CODICE	mm	A/mm	B/mm	D/mm	E/mm	€/Pz
FG 625/C21	21	28.3	27.5	38.1	14.0	5,80
FG 625/C22	22	29.9	28.6	38.1	14.2	7,20
FG 625/C23	23	31.2	29.9	38.1	14.5	7,80
FG 625/C24	24	32.5	31.0	38.1	15.5	7,80
FG 625/C25	25	33.3	32.6	38.1	15.5	7,80
FG 625/C26	26	34.6	33.4	41.3	16.0	7,90
FG 625/C27	27	36.5	34.9	44.5	19.6	7,90
FG 625/C28	28	41.0	39.6	44.5	19.6	8,00
FG 625/C29	29	42.5	41.2	47.6	19.6	8,00
FG 625/C30	30	41.0	39.6	44.5	19.6	8,00
FG 625/C32	32	42.5	41.2	47.6	19.6	8,30

Set chiavi a bussola poligonali da 1/2"

CODE	Pz	CONTENUTO	€/Pz
FG 625/S11	11	8,10,11,12,13,14,15,16,17,18,19	68,00
FG 625/S12B	12	20,21,22,23,24,25,26,27,28,29,30,32	82,00

Set 11 chiavi a bussola esagonali e cricchetto su supporto in plastica

CODE	Pz	CONTENUTO	€/Pz
FG 625/S12	12	8,10,11,12,13,14,15,16,17,18,19 + FG 625/CR12	108,00



Set 25 utensili con attacco quadro 1/2"

CODICE	Pz	€/Pz
FG 625C/S25	25	230,00



FG 625/C10,11,12,13,14,15,16,17,18, 19,20,21,22, 23,24,25,26,27,30,32mm

FG 625/CR12

FG 625/PA125, 250

FG 625/ES12

FG 625/SN12

Modulo in gomma 25 utensili da 1/2"

CODICE	Pz	€/Pz
FG 100/21C	25	220,00



Modulo rigido 25 utensili da 1/2"

CODICE	Pz	€/Pz
FG 102/21C	25	202,00



FG 625/C10,11,12,13,14,15,16,17,18, 19,20,21,22, 23,24,25,26,27,30,32mm

FG 625/CR12

FG 625/PA125, 250

FG 625/ES12

FG 625/SN12

CHIAVE A BUSSOLA 1/2" POLIGONALE - serie lunga

- **UTILIZZO**

bulloni poligonali

- **FINITURA**

cromata lucida

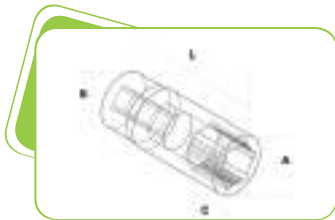

Set 37 utensili con attacco quadro 1/2"

CODICE	Pz	€/Pz
FG 625/S37	37	410,00



**FG 625/C8, 9, 10,11,12,13,
14,15,16,17, 18,19,20,21,22,23,
24,26, 27,30,32mm**



**FG 625/L10,12,13,14,17,19,21,
22,24,27,30mm**



FG 625/CR12



FG 625/PA125, 250



FG 625/ES12



FG 625/SN12

CODICE	mm	A/mm	B/mm	C/mm	L/mm	€/Pz
FG 625/L8	8	13,0	21,9	16,7	77,0	8,70
FG 625/L9	9	14,0	21,9	17,0	77,0	8,70
FG 625/L10	10	15,5	21,9	19,5	77,0	8,70
FG 625/L11	11	16,5	21,9	17,6	77,0	8,70
FG 625/L12	12	17,7	21,9	19,0	77,0	8,70
FG 625/L13	13	19,0	21,9	19,0	77,0	8,70
FG 625/L14	14	20,4	21,9	33,0	77,0	8,70
FG 625/L15	15	21,9	20,5	31,5	77,0	8,70
FG 625/L16	16	22,0	20,5	31,7	77,0	8,70
FG 625/L17	17	23,9	22,0	32,0	77,0	8,70
FG 625/L18	18	26,0	23,0	31,0	77,0	8,80
FG 625/L19	19	26,0	24,0	35,6	77,0	8,80
FG 625/L20	20	27,7	25,7	31,6	77,0	10,20
FG 625/L21	21	27,6	26,0	35,5	77,0	11,40
FG 625/L22	22	29,7	26,0	32,0	77,0	12,70
FG 625/L23	23	31,8	27,7	31,0	77,0	12,70
FG 625/L24	24	31,8	28,0	32,4	77,0	12,70
FG 625/L25	25	33,8	29,7	31,6	77,0	14,30
FG 625/L27	27	35,8	30,7	31,3	77,0	16,80
FG 625/L30	30	39,8	33,8	31,3	77,0	21,80
FG 625/L32	32	42,0	35,0	31,6	77,0	22,50
FG 625/L36	36	48,0	40,0	35,0	77,5	39,50

Set chiavi a bussola poligonali da 1/2"

CODICE	Pz	CONTENUTO	€/Pz
FG 625L/S12	12	8,9,10,11,12,13,14,15,16,17,18,19mm	110,00
FG 625L/S6	6	21,22,24,27,30,32mm	105,00

Modulo 37 utensili con attacco quadro 1/2"

CODICE	Pz	€/Pz
FG 100/21L	37	385,00



**FG 625/C8, 9, 10,11,12,13,
14,15,16,17, 18,19,20,21,22,23,
24,26, 27,30,32mm**



**FG 625/L10,12,13,14,17,19,21,
22,24,27,30mm**



FG 625/CR12



FG 625/PA125, 250



FG 625/ES12



FG 625/SN12



CHIAVE A BUSSOLA 1/2" POLIGONALE in pollici

UTILIZZO

bulloni in pollici

FINITURA

cromata lucida

CODICE	"	A/mm	B/mm	D/mm	E/mm	€/Pz
FG 625C/IN1	5/16	14.9	21.8	38.1	7.5	4,80
FG 625C/IN2	3/8	14.9	21.8	38.1	7.5	4,80
FG 625C/IN3	7/16	16.5	21.8	38.1	8.0	4,80
FG 625C/IN4	15/32	18.2	21.8	38.1	9.1	4,80
FG 625C/IN5	1/2	19.0	21.8	38.1	10.7	4,80
FG 625C/IN6	9/16	20.5	21.8	38.1	10.7	4,80
FG 625C/IN7	19/32	22.2	22.6	38.1	10.7	4,80
FG 625C/IN8	5/8	23.8	22.6	38.1	12.7	4,80
FG 625C/IN9	11/16	24.5	22.9	38.1	12.7	4,80
FG 625C/IN10	3/4	26.3	24.8	38.1	14.0	5,60
FG 625C/IN11	25/32	27.1	26.12	38.21	14.0	6,00
FG 625C/IN12	13/16	28.3	27.5	38.1	14.0	6,00
FG 625C/IN13	7/8	29.9	28.6	38.1	14.2	7,30



CODICE	"	A/mm	B/mm	D/mm	E/mm	€/Pz
FG 625C/IN14	15/16	32.5	31.0	38.1	15.5	8,00
FG 625C/IN15	1	33.3	32.6	38.1	15.5	8,00
FG 625C/IN16	1.1/16	36.5	34.9	44.5	19.6	9,20
FG 625C/IN17	1.1/8	36.5	34.9	44.5	19.6	9,60
FG 625C/IN18	1.3/16	41.0	39.6	44.5	19.6	10,10
FG 625C/IN19	1.1/4	42.5	41.2	47.6	19.6	10,10

Set 11 chiavi a bussola poligonali in pollici da 1/2"

CODICE	Pz	CONTENUTO	€/Pz
FG 625IN/S11	11	3/8, 7/16, 1/2, 9/16, 5/8, 11/16, 3/4, 13/16, 7/8, 15/16, 1"	65,90



Set 24 utensili con attacco quadro 1/2"

CODICE	Pz	€/Pz
FG 625IN/S24	24	237,90



5/16, 3/8, 7/16, 15/32, 1/2, 9/16, 19/32, 5/8, 11/16, 3/4, 25/32, 13/16, 7/8, 15/16, 1, 1.1/16, 1.1/8, 1.3/16, 1.1/4

FG 625/CR12

FG 625/PA125,250

FG 625/ES12

FG 625/SN12

Modulo in gomma 24 utensili da 1/2"

CODICE	Pz	€/Pz
FG 100/211N	24	227,00



5/16, 3/8, 7/16, 15/32, 1/2, 9/16, 19/32, 5/8, 11/16, 3/4, 25/32, 13/16, 7/8, 15/16, 1, 1.1/16, 1.1/8, 1.3/16, 1.1/4

FG 625/CR38

FG 625/PA125,250

FG 625/ES12

FG 625/SN12

CHIAVE A BUSSOLA 1/2" UNIVERSALE

- UTILIZZO

bulloni Esagonali (Integri e danneggiati fino al 50%), Torx, Quadrati, XZN e Poligonali

CODICE	mm	E	■	B/mm	C/mm	L/mm	€/Pz
FG 626/A8	8	E10		13.5	21.9	38.1	6,20
FG 626/A10	10	E12	8	15.6	21.9	38.1	6,40
FG 626/A11	11	E14		16.7	21.9	38.1	6,40
FG 626/A12	12	E16	10	18.0	21.9	38.1	6,40
FG 626/A13	13	E18	11	19.1	21.9	38.1	6,40
FG 626/A14	14		12	20.8	22.0	38.1	6,40
FG 626/A15	15			23.0	22.0	38.1	6,40
FG 626/A16	16	E20		24.0	22.0	38.1	6,60
FG 626/A17	17		13	24.5	22.0	38.1	6,60
FG 626/A18	18	E22	15	26.0	23.0	38.1	6,60
FG 626/A19	19	E24	16	27.5	24.0	38.1	7,10
FG 626/A20	20			28.5	24.0	38.1	7,10
FG 626/A21	21			28.5	24.0	38.1	7,10

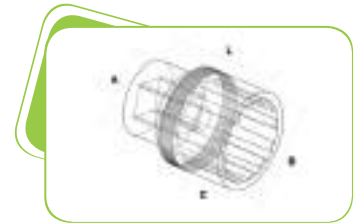

CODICE	mm	E	■	B/mm	C/mm	L/mm	€/Pz
FG 626/A22	22	E28		30.5	24.0	38.1	7,40
FG 626/A23	23			28.5	24.0	38.1	7,70
FG 626/A24	24	E30		32.5	25.0	40.0	7,90
FG 626/A27	27	E32		37.0	28.0	42.0	9,70
FG 626/A30	30			41.8	29.0	45.0	11,00
FG 626/A32	32			43.8	30.0	45.0	11,70



Set chiavi a bussola universali da 1/2"

CODICE	Pz	CONTENUTO	€/Pz
FG 626/S13	13	8,10,11,12,13,14,15,16,17,18,19,20,21 mm	92,00
FG 626/S6	6	22, 23, 24, 27, 30, 32 mm	59,00



Set 23 utensili con attacco quadro 1/2"

CODICE	Pz	€/Pz
FG 626/S23	23	256,00

- FG 626/A8,10,11,12,13,14,15,16,17,18,19,20,21,22,24,27,30,32mm
- FG 625/CR12
- FG 625/PA125, 250
- FG 625/ES12
- FG 625/SN12

Modulo in gomma 23 utensili da 1/2"

CODICE	Pz	€/Pz
FG 100/20B	23	245,00



- FG 626/A8,10,11,12,13,14,15,16,17,18,19,20,21,22,24,27,30,32mm
- FG 625/CR12
- FG 625/PA125, 250
- FG 625/ES12
- FG 625/SN12



CHIAVE A BUSSOLA 1/2" TORX

→ **UTILIZZO**
bulloni Torx

→ **FINITURA**
cromata lucida



CODICE	E	A/mm	B/mm	L/mm	€/Pz
FG 625/TX8	8	21.8	17.8	38.1	6,40
FG 625/TX10	10	21.8	15.4	38.1	6,40
FG 625/TX12	12	21.8	17.8	38.1	6,40
FG 625/TX14	14	21.8	20.4	38.1	6,40
FG 625/TX16	16	21.8	21.8	38.1	6,40
FG 625/TX18	18	21.8	21.8	38.1	6,40
FG 625/TX20	20	22.8	22.8	38.1	6,40
FG 625/TX22	22	24.0	25.8	38.1	6,40
FG 625/TX24	24	26.0	27.8	40.0	6,40

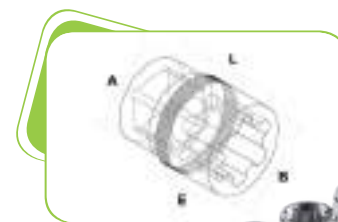

Set 9 chiavi a bussola 1/2" Torx

CODICE	Pz	CONTENUTO	€/Pz
FG 625TX/S9	9	8, 10, 12, 14, 16, 18, 20, 22, 24 E	68,00

CHIAVE A BUSSOLA 1/2" TORX serie lunga

→ **UTILIZZO**
bulloni Torx

→ **FINITURA**
cromata lucida



CODICE	E	A/mm	B/mm	L/mm	€/Pz
FG 625L/TX8	8	21.8	11.8	77.0	12,00
FG 625L/TX10	10	21.8	15.4	77.0	12,00
FG 625L/TX12	12	21.8	17.8	77.0	12,00
FG 625L/TX14	14	21.8	20.4	77.0	12,00
FG 625L/TX16	16	21.8	21.8	77.0	12,00
FG 625L/TX18	18	21.8	21.8	77.0	12,00
FG 625L/TX20	20	23.8	23.8	77.0	12,00
FG 625L/TX22	22	24.0	25.8	77.0	12,00
FG 625L/TX24	24	26.0	27.8	77.0	12,00



Set 9 chiavi a bussola 1/2" Torx

CODICE	Pz	CONTENUTO	€/Pz
FG 625LTX/S9	9	8, 10, 12, 14, 16, 18, 20, 22, 24 E	115,00

Modulo in gomma 44 utensili TORX

CODICE	Pz	€/Pz
FG 100/21TX	44	230,00



Modulo rigido 44 utensili TORX

CODICE	Pz	€/Pz
FG 102/21TX	44	210,00



 **FG 624/TX4 - TX10**

 **FG 625/TX8 - TX24**

 **FG 147/TX9 - TX40**

 **FG 150/TX10 - TX60**

 **FG 139/C**



INSERTO A BUSSOLA TORX 1/2"



CODICE	TX	L/mm	€/Pz
FG 150/TX6	6	55	11,60
FG 150/TX7	7	55	11,60
FG 150/TX8	8	55	11,60
FG 150/TX9	9	55	11,60
FG 150/TX10	10	55	11,60
FG 150/TX15	15	55	11,60
FG 150/TX20	20	55	11,60
FG 150/TX25	25	55	11,60
FG 150/TX27	27	55	11,60
FG 150/TX30	30	55	11,80
FG 150/TX40	40	55	11,80
FG 150/TX45	45	55	12,50
FG 150/TX50	50	55	12,50
FG 150/TX55	55	55	13,50
FG 150/TX60	60	55	14,50
FG 150/TX70	70	55	14,50

CODICE	TX	L/mm	€/Pz
FG 150L/TX20	20	100	13,50
FG 150L/TX25	25	100	13,50
FG 150L/TX27	27	100	13,50
FG 150L/TX30	30	100	13,70
FG 150L/TX40	40	100	13,70
FG 150L/TX45	45	100	14,00
FG 150L/TX50	50	100	14,00
FG 150L/TX55	55	100	14,80
FG 150L/TX60	60	100	14,90
FG 150L/TX70	70	100	16,50



XL

XXL

CODICE	TX	L/mm	€/Pz
FG 150XL/TX40	40	140	16,50
FG 150XL/TX45	45	140	16,50
FG 150XL/TX50	50	140	16,50
FG 150XL/TX55	55	140	16,50
FG 150XL/TX60	60	140	22,80
FG 150XL/TX70	70	140	25,30

CODICE	TX	L/mm	€/Pz
FG 150XXL/TX40	40	200	23,00
FG 150XXL/TX45	45	200	23,00
FG 150XXL/TX50	50	200	23,00
FG 150XXL/TX55	55	200	23,00
FG 150XXL/TX60	60	200	30,00
FG 150XXL/TX70	70	200	33,50

Set 11 inserti a bussola TORX 1/2"

CODICE	Pz	CONTENUTO	€/Pz
FG 150TX/S11	11	TX10, TX15, TX20, TX25, TX27, TX30, TX40, TX45, TX50, TX55, TX60	145,00

Set 6 inserti a bussola TORX 1/2"

CODICE	Pz	CONTENUTO	€/Pz
FG 150LTX/S6	6	TX30, TX40, TX45, TX50, TX55, TX60	90,00



Set 32 inserti a bussola TORX 1/2"

CODICE	€/Pz
FG 150TX/S32	166,00

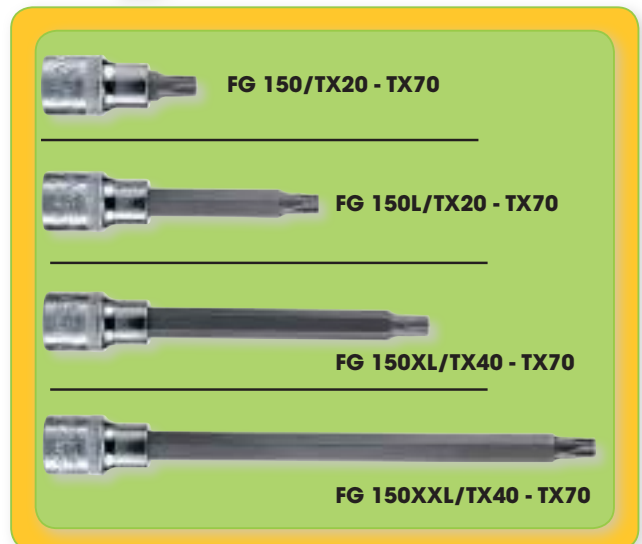



Set chiavi a bussola TX e inserti a bussola TX

CODICE	Pz	€/Pz
FG 625TX/S23	23	200,00



FG 624/TX4, TX5, TX6, TX7, TX8, TX10



FG 625/TX12, TX14, TX16, TX18, TX20, TX22, TX24



FG 150/TX10, TX15, TX20, TX25, TX27, TX30, TX40



FG 625/CR12



FG 625/PA125



Set chiavi a bussola TX e inserti a bussola TX

CODICE	Pz	€/Pz
FG 625TX/S9B	9	66,00



FG 625/TX10, TX12, TX14, TX16, TX18



FG 150/TX25, TX27, TX30, TX40



Set 13 chiavi a bussola snodate con impronta Torx

CODICE	Pz	CONTENUTO	€/Pz
FG 625TX/S13	13	1/4": E4,E5,E6,E7,E8 3/8": E10,E12,E14,E16 1/2": E18,E20,E22,E24	150,00



NEW



INSERTO A BUSSOLA XZN 1/2"



CODICE	M	L/mm	€/Pz
FG 150/M5	5	55	11,80
FG 150/M6	6	55	11,80
FG 150/M8	8	55	11,80
FG 150/M9	9	55	11,80
FG 150/M10	10	55	11,80
FG 150/M12	12	55	11,80
FG 150/M14	14	55	11,80
FG 150/M16	16	55	12,40

CODICE	TX	L/mm	€/Pz
FG 150L/M5	5	100	13,70
FG 150L/M6	6	100	13,70
FG 150L/M8	8	100	13,70
FG 150L/M9	9	100	13,70
FG 150L/M10	10	100	13,70
FG 150L/M12	12	100	13,70
FG 150L/M14	14	100	13,70

XL

CODICE	TX	L/mm	€/Pz
FG 150XL/M5	5	140	16,50
FG 150XL/M6	6	140	16,50
FG 150XL/M8	8	140	16,50
FG 150XL/M9	9	140	16,50
FG 150XL/M10	10	140	16,50
FG 150XL/M12	12	140	23,00
FG 150XL/M14	14	140	25,30

XXL

CÓDIGO	M	L/mm	€/Pz
FG 150XXL/M8	8	200	23,00
FG 150XXL/M10	10	200	23,00
FG 150XXL/M12	12	200	30,00
FG 150XXL/M14	14	200	33,50

Set 7 inserti a bussola XZN 1/2" su supporto in plastica

CODICE	Pz	CONTENUTO	€/Pz
FG 150M/S7	7	M5, M6, M8, M10, M12, M14, M16	86,00

Set 6 inserti a bussola XZN 1/2" su supporto in plastica

CODICE	Pz	CONTENUTO	€/Pz
FG 150LM/S7	7	LM5, LM6, LM8, LM9, LM10, LM12, LM14	99,50



Set 26 inserti a bussola XZN 1/2"

CODICE	€/Pz
FG 150M/S26	160,00

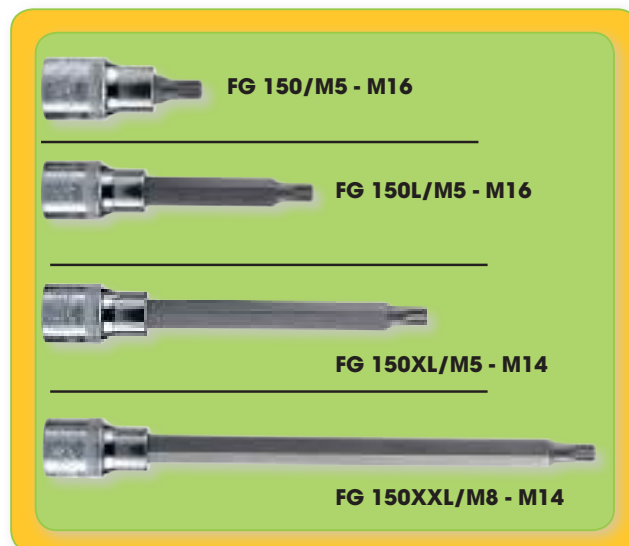

INSERTO A BUSSOLA RIBE 1/2"

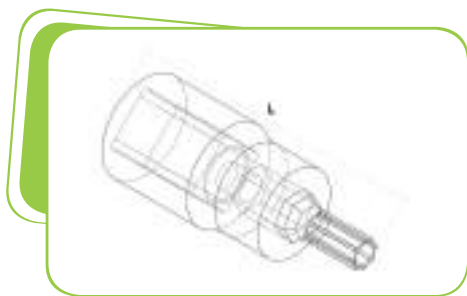

CODICE	R	L/mm	€/Pz
FG 150/R4	4	55	11,40
FG 150/R5	5	55	11,40
FG 150/R6	6	55	11,40
FG 150/R7	7	55	11,40
FG 150/R8	8	55	11,40

CODICE	R	L/mm	€/Pz
FG 150/R9	9	55	11,40
FG 150/R10	10	55	11,40
FG 150/R11	11	55	11,40
FG 150/R12	12	55	11,40
FG 150/R13	13	55	11,80
FG 150/R14	14	55	11,80

Set 11 inserti a bussola RIBE 1/2" su supporto in materiale plastico

CODICE	Pz	CONTENUTO	€/Pz
FG 150R/S11	11	R4, R5, R6, R7, R8, R9, R10, R11, R12, R13, R14	126,00



INSERTO A BUSSOLA RIBE 1/2" serie lunga

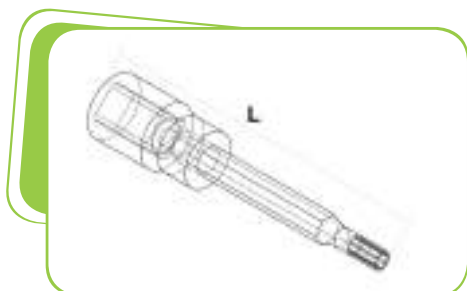

CODICE	R	L/mm	€/Pz
FG 150L/R4	4	100	12,80
FG 150L/R5	5	100	12,80
FG 150L/R6	6	100	12,80
FG 150L/R7	7	100	12,80
FG 150L/R8	8	100	12,80

CODICE	R	L/mm	€/Pz
FG 150L/R9	9	100	12,80
FG 150L/R10	10	100	12,80
FG 150L/R11	11	100	12,80
FG 150L/R12	12	100	12,80
FG 150L/R13	13	100	12,80
FG 150L/R14	14	100	12,80

Modulo inserti a bussola RIBE 1/2"

CODICE	Pz	CONTENUTO	€/Pz
FG 100/82B	22	R4 - R14 LR4 - LR14	276,50

Modulo rigido inserti a bussola RIBE 1/2"

CODICE	Pz	CONTENUTO	€/Pz
FG 102/21R	22	R4 - R14 LR4 - LR14	266,50



INSERTO A BUSSOLA RIBE FORATO 1/2"

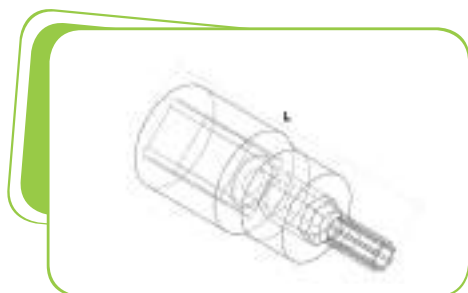

CODICE	R	L/mm	€/Pz
FG 150/RF4	4	55	12,70
FG 150/RF5	5	55	12,70
FG 150/RF6	6	55	12,70
FG 150/RF7	7	55	12,70
FG 150/RF8	8	55	13,00

CODICE	R	L/mm	€/Pz
FG 150/RF9	9	55	13,10
FG 150/RF10	10	55	13,10
FG 150/RF11	11	55	13,30
FG 150/RF12	12	55	13,40
FG 150/RF13	13	55	14,00
FG 150/RF14	14	55	13,60

Set 11 inserti a bussola RIBE FORATI 1/2" su supporto in plastica

CODICE	Pz	CONTENUTO	€/Pz
FG 150RF/S11	11	RF4 - RF14	150,00



INSERTO A BUSSOLA RIBE FORATO 1/2" serie lunga

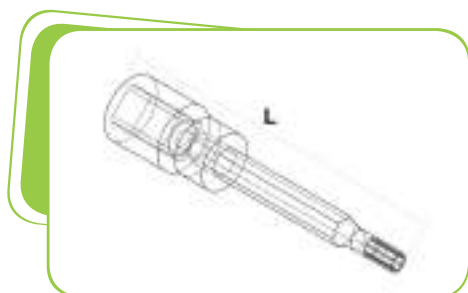

CODICE	R	L/mm	€/Pz
FG 150L/RF4	4	100	13,20
FG 150L/RF5	5	100	13,20
FG 150L/RF6	6	100	13,20
FG 150L/RF7	7	100	13,20
FG 150L/RF8	8	100	13,70

CODICE	R	L/mm	€/Pz
FG 150L/RF9	9	100	13,70
FG 150L/RF10	10	100	13,80
FG 150L/RF11	11	100	14,00
FG 150L/RF12	12	100	14,10
FG 150L/RF13	13	100	14,10
FG 150L/RF14	14	100	14,60

Modulo inserti a bussola RIBE FORATI da 1/2"

CODICE	Pz	CONTENUTO	€/Pz
FG 100/83B	22	RF4 - RF14 LRF4 - LRF14	289,00

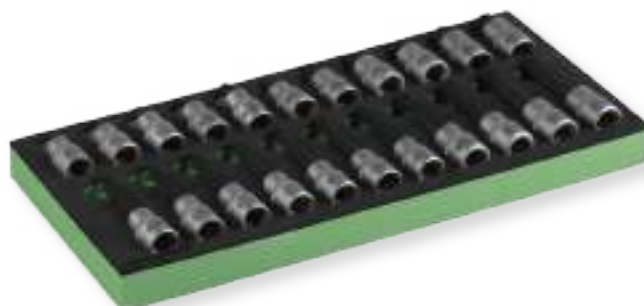

INSERTO A BUSSOLA ESAGONALE 1/2"

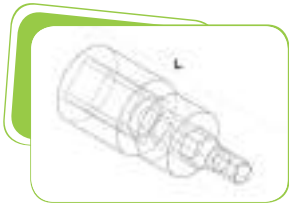

CODICE	mm	L/mm	€/Pz
FG 150/H2	2	55	11,00
FG 150/H2.5	2.5	55	11,00
FG 150/H3	3	55	11,00
FG 150/H4	4	55	11,00
FG 150/H5	5	55	11,00
FG 150/H6	6	55	11,00
FG 150/H8	8	55	11,00
FG 150/H10	10	55	11,00
FG 150/H12	12	55	13,00
FG 150/H14	14	55	13,00
FG 150/H17	17	55	14,50
FG 150/H19	19	55	16,00

CODICE	mm	L/mm	€/Pz
FG 150L/H2	2	100	11,30
FG 150L/H2.5	2.5	100	11,30
FG 150L/H3	3	100	11,30
FG 150L/H4	4	100	11,30
FG 150L/H5	5	100	11,30
FG 150L/H6	6	100	11,30
FG 150L/H7	7	100	11,30
FG 150L/H8	8	100	11,30
FG 150L/H10	10	100	11,30
FG 150L/H11	11	100	12,50
FG 150L/H12	12	100	14,00
FG 150L/H13	13	100	14,00

XL

CODICE	mm	L/mm	€/Pz
FG 150XL/H5	5	140	16,00
FG 150XL/H6	6	140	16,00
FG 150XL/H7	7	140	16,00
FG 150XL/H8	8	140	16,00
FG 150XL/H10	10	140	16,50
FG 150XL/H12	12	140	21,00
FG 150XL/H14	14	140	24,00

XXL

CODICE	mm	L/mm	€/Pz
FG 150XXL/H5	5	200	22,50
FG 150XXL/H6	6	200	22,50
FG 150XXL/H7	7	200	22,50
FG 150XXL/H8	8	200	22,50
FG 150XXL/H10	10	200	23,50
FG 150XXL/H12	12	200	27,50

Set 12 inserti a bussola esagonali 1/2"

CODICE	Pz	CONTENUTO	€/Pz
FG 150H/S12	12	2, 2.5, 3, 4, 5, 6, 8, 10, 12, 14, 17, 19mm	120,00

Set 9 inserti a bussola esagonali 1/2"

CODICE	Pz	CONTENUTO	€/Pz
FG 150H/S9	9	4, 5, 6, 8, 10, 5L, 6L, 8L, 10L mm	102,00

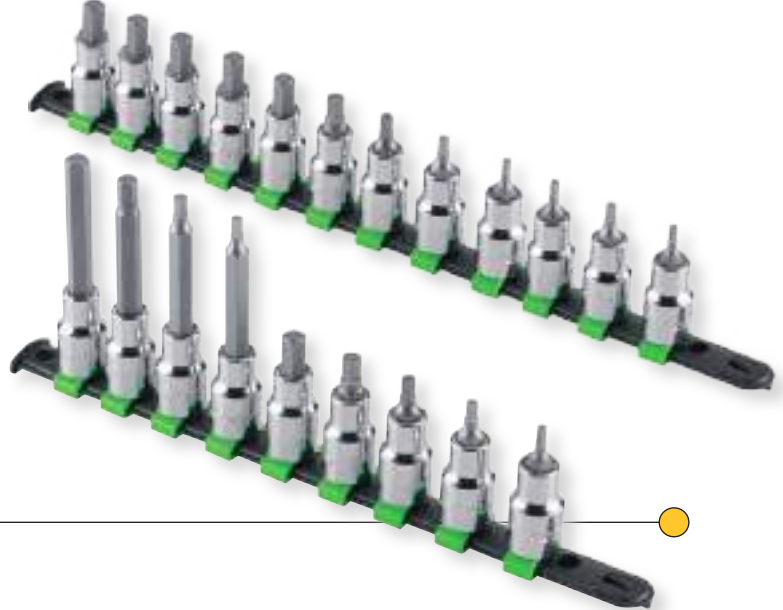

Set 30 inserti a bussola H - 1/2"

CODICE	€/Pz
FG 150H/S30	180,00



FG 150/H5 - H19



FG 150L/H5 - H13



FG 150XL/H5 - H14



FG 150XXL/H5 - H12

INSERTO A BUSSOLA ESAGONALE 1/2" CON ESTREMITA' SFERICA

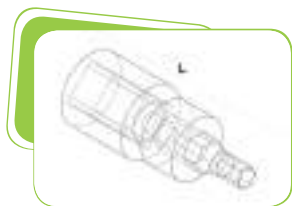

NEW

CODICE	mm	L/mm	€/Pz
FG 150L/H5B	5	100	12,50
FG 150L/H6B	6	100	12,50
FG 150L/H7B	7	100	12,50
FG 150L/H8B	8	100	12,50
FG 150L/H10B	10	100	12,50

CODICE	mm	L/mm	€/Pz
FG 150XXL/H5B	5	200	17,50
FG 150XXL/H6B	6	200	17,50
FG 150XXL/H7B	7	200	17,50
FG 150XXL/H8B	8	200	17,50
FG 150XXL/H10B	10	200	17,50

Set 10 inserti a bussola esagonali 1/2" con estremità sferica

CODICE	Pz	CONTENUTO	€/Pz
FG 150H/S10B	10	5L, 6L, 7L, 8L, 10L, 5XXL, 6XXL, 7XXL, 8XXL, 10XXL	155,00

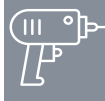

Inserto a bussola rinforzato XZN - 1/2"

CODICE	mm	L/mm	€/Pz
FG 152/RM5	5	60	10,40
FG 152/RM6	6	60	10,40
FG 152/RM8	8	60	10,40
FG 152/RM9	9	60	10,40
FG 152/RM10	10	78	10,40
FG 152/RM12	12	78	11,90
FG 152/RM14	14	78	11,90
FG 152/RM16	16	78	11,90
FG 152/RM18	18	78	11,90

Set 9 inserti a bussola XZN rinforzati 1/2"

RM5, RM6, RM8, RM9, RM10, RM12, RM14, RM16, RM18

CODICE	Pz	€/Pz
FG 152RM/S9	9	108,00



Inserto a bussola rinforzato esagonale - 1/2"

CODICE	mm	L/mm	€/Pz
FG 152/RH5	5	60	10,50
FG 152/RH6	6	60	10,50
FG 152/RH7	7	60	10,50
FG 152/RH8	8	60	10,50
FG 152/RH10	10	68	10,50
FG 152/RH12	12	68	10,50
FG 152/RH14	14	78	12,10
FG 152/RH17	17	78	12,10
FG 152/RH19	19	78	12,10

Set 9 inserti a bussola esagonali rinforzati

RH5, RH6, RH7, RH8, RH10, RH12, RH14, RH17, RH19

CODICE	Pz	€/Pz
FG 152RH/S9	9	108,00



Inserto a bussola rinforzato Torx - 1/2"

CODICE	mm	L/mm	€/Pz
FG 152/RTX20	20	60	13,20
FG 152/RTX25	25	60	13,20
FG 152/RTX27	27	60	13,20
FG 152/RTX30	30	60	13,20
FG 152/RTX40	40	60	13,20
FG 152/RTX45	45	68	14,20
FG 152/RTX50	50	68	15,20
FG 152/RTX55	55	68	15,20
FG 152/RTX60	60	68	15,20
FG 152/RTX70	70	78	15,20

Set 10 inserti a bussola Torx rinforzati

RTX20, RTX25, RTX27, RTX30, RTX40, RTX45, RTX50, RTX55, RTX60, RTX70

CODICE	Pz	€/Pz
FG 152RTX/S10	10	150,00





Cricchetto reversibile 1/2" a 72 denti

CODICE	L/mm	■	€/Pz
FG 625/CR12	250	1/2"	42,00

- Sistema di inversione a ghiera integrato sulla testa
- Meccanismo a 72 denti
- Cromatura lucida
- Asola di aggancio

Quadro maschio 1/2" snodato con impugnatura

CODICE	L/mm	€/Pz
FG 625/CS12	246	37,00
FG 625/CS12B	381	42,00



Quadro maschio snodato con attacco 1/2"

CODICE	L/mm	€/Pz
FG 625/Q12	500	42,00

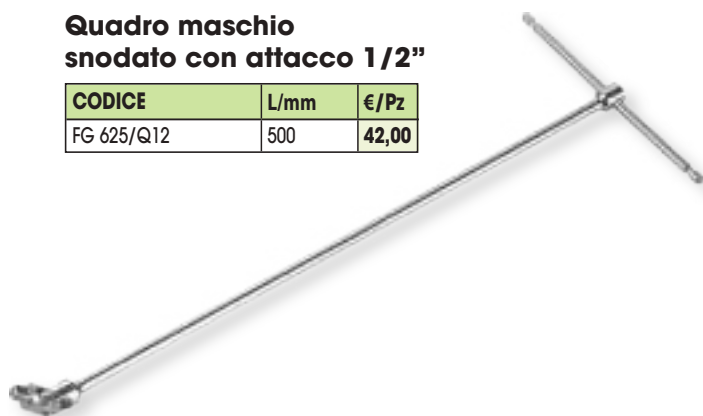

Quadro maschio con attacco scorrevole 1/2"

CODICE	L/mm	€/Pz
FG 625/ES12	305	14,00



Snodo con attacco quadro maschio e femmina 1/2"

CODICE	L/mm	€/Pz
FG 625/SN12	76	18,00



Cricchetto reversibile 1/2" con impugnatura rotante - 60 denti

CODICE	L/mm	■	€/Pz
FG 625/RT12	260	1/2"	65,00



Cricchetto reversibile 1/2" a 72 denti

CODICE	■	€/Pz
FG 625/FR12	1/2"	49,00

NEW



- Modello con testa chiusa anti polvere
- Leva di inversione integrata a filo testa
- Corpo scavato di 13° per consentire l'utilizzo anche in spazi particolarmente difficili
- Meccanismo a 72 denti
- Cromatura lucida
- Asola di aggancio

Prolunga con attacco quadro maschio e femmina 1/2" - angolare

CODICE	L/mm	€/Pz
FG 625/PA50	50	9,50
FG 625/PA75	75	11,50
FG 625/PA125	125	13,50
FG 625/PA250	250	17,50



Prolunga con attacco quadro maschio e femmina 1/2"

CODICE	L/mm	€/Pz
FG 625/PR50	50	9,00
FG 625/PR75	75	10,00
FG 625/PR125	125	11,00
FG 625/PR250	250	13,00





1/2"

1/4"



CODICE	CONTENUTO	€/Pz
FG 625/S70	70PZ	240,00

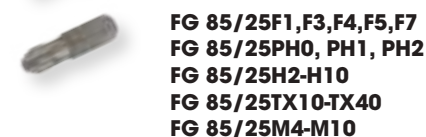
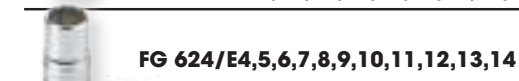

1/2"

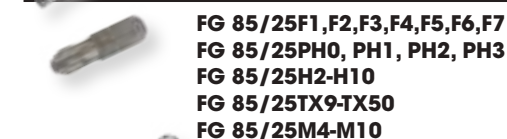

CODICE	CONTENUTO	€/Pz
FG 625/S64	64pz	220,00



SET ASSORTITI

1/2"



FG 625/A8,9,10,11,12,13,14,15,16,17,
18,19,20,21,22,23,24,25,26,27,30,32



FG 625/CR12



FG 625/SN12



FG 625/ES12



FG 625/PA125, 250

Set 27 utensili con aggancio 1/2"

CODICE	CONTENUTO	€/Pz
FG 625/S27	27pz	130,00

Set 74 utensili con aggancio 1/4" e 1/2"

CODICE	CONTENUTO	€/Pz
FG 625/S74	74pz	200,00

1/4" 1/2"



FG 625/A8,9,10,11,12,13,14,15,16,17,18,19,20,21,22,23,24,25,26,27,30,32



FG 624/E4,5,6,7,8,9,10,11,12,13,14



FG 624/CR14
FG 625/CR12



FG 625/SN12
FG 624/SN14



FG 625/ES12
FG 624/ES14



FG 624/GR14C



FG 625/PA125
FG 624/PA50, 100



FG 89/38PI1 1/4"x1/4"



FG 85/25PH1, PH2, PH3
FG 85/25SL3, SL4, SL4.5, SL5, SL5.5, SL6, L6.5
FG 85/25PZ1, PZ2, PZ3
FG 85/H1.5, H2, 2.5, H3, H4, H5, H6
FG 85/25T9, T10, T15, T20, T25, T27, T30, T40

Set 94 utensili con aggancio 1/4" e 1/2"

CODICE	CONTENUTO	€/Pz
FG 625/S94	94pz	230,00

1/4" 1/2"



FG 625/A8,9,10,11,12,13,14,15,16,17,18,19,20,21,22,23,24,25,26,27,30,32



FG 624/E4,5,6,7,8,9,10,11,12,13,14



FG 625L/A10,13,14,15,17,19



FG 624E/L4,5,6,7,8,9,10,11,12,13,14



FG 624/CR14
FG 625/CR12



FG 625/SN12
FG 624/SN14



FG 625/ES12
FG 624/ES14



FG 624/GR14C



FG 625/PA125, 250
FG 624/PA50, 100



FG 89/38PI1 1/4"x1/4"



FG 85/25PH1, PH2, PH3
FG 85/25SL3, SL4, SL4.5, SL5, SL5.5, SL6, L6.5
FG 85/25PZ1, PZ2, PZ3
FG 85/H1.5, H2, 2.5, H3, H4, H5, H6
FG 85/25T9, T10, T15, T20, T25, T27, T30, T40
FG 88/60PI2



Set 109 utensili con aggancio 1/4" e 1/2"

CODICE	CONTENUTO	€/Pz
FG 625/S109	109pz	265,00



1/4"

1/2"



FG 625/A8,9,10,11,12,13,14,15,16,17,18,19,20,21,22,23,24,25,26,27,30,32



FG 624/E4,5,6,7,8,9,10,11,12,13,14

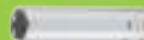

FG 624E/L4,5,6,7,8,9,10,11,12,13,14



FG 147/H2,5,3,4,5,6,7,8,10



FG 147/TX9,10,15,20,25,27,30,40

FG 624/CR14
FG 625/CR12FG 625/SN12
FG 624/SN14FG 625/ES12
FG 624/ES14

FG 624/GR14C

FG 625/PA125, 250
FG 624/PA50

FG 89/38PI1 1/4"x1/4"



FG 92/P



FG 600/B8,10,13,15,17,19

FG 85/25PH1, PH2, PH3, PZ1, PZ2, PZ3
FG 85/25SL3, SL4, SL4.5, SL5, SL5.5, SL6, L6.5
85/H1.5, H2, 2.5, H3, H4, H5, H6
FG 85/25TX9 - TX40, FG 88/60PI2

Set 102 utensili con aggancio 1/4", 3/8" e 1/2"

CODICE	CONTENUTO	€/Pz
FG 625/S102	102pz	330,00



1/4"

3/8"

1/2"



FG 625/A8,9,10,11,12,13,14,15,16,17,18,19,20,21,22,23,24,25,26,27,30,32



FG 624/E4,5,6,7,8,9,10,11,12,13,14



FG 624/B8,9,10,11,12,13,14,15,16,17,18,19,21,22,23



FG 624/CR14, FG 624/CR38, FG 625/CR12



FG 625/SN14, FG 624/SN38, FG 624/SN12



FG 625/ES14, FG 624/ES38, FG 624/ES12

FG 625/PA125, 250
FG 624/PA100, FG 624B/PR125

FG 88/P14



FG 600/B8,10,13,15,17,19

FG 85/25PH1, PH2, PH3
FG 85/25SL3, SL4, SL4.5, SL5, SL5.5, SL6, L6.5
FG 85/25PZ1, PZ2, PZ3
FG 85/H1.5, H2, 2.5, H3, H4, H5, H6
FG 85/25T9, T10, T15, T20, T25, T27, T30, T40
FG 88/60PI2

FG TOP 620/A10, 13, 17



Set 110 utensili con
aggancio 1/4" e 1/2"

CODICE	CONTENUTO	€/Pz
FG 625/S110	110pz	380,00

1/4" 1/2"



FG 625/A8,9,10,11,12,13,14,15,16,17,
18,19,20,21,22,23,24,25,26,27,30,32



FG 624/E4,5,6,7,8,9,10,11,12,13,14



FG 624/CR14
FG 625/CR12



FG 625/SN12
FG 624/SN14



FG 625/ES12
FG 624/ES14

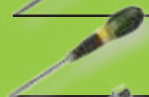

FG 624/GR14C



FG 625/PA125, 250
FG 624/PA50, 100



FG 89/38PI1 1/4"x1/4"

FG 85/25PH1, PH2, PH3
FG 85/25SL3, SL4, SL4.5, SL5, SL5.5, SL6, L6.5
FG 85/25PZ1, PZ2, PZ3
FG 85/H1.5, H2, 2.5, H3, H4, H5, H6
FG 85/25T9, T10, T15, T20, T25, T27, T30, T40
FG 88/60PI2



FG 139/B



FG 48/L



FG 49



FG 600/B8,10,11,12,
13,14,15,17,19



FG 22/3x75, 4x100, 5.5x100
FG 22/PH0x60, PH1x80, PH2x100



FG 59SR/160
FG 63SR/160



FG 58/B240



FG 132/H500



FG 79/SP



FG 92/P



FG 44/MT5

CHIAVE A BUSSOLA 3/4" ESAGONALE

UTILIZZO

bulloni esagonali

FINITURA

cromata lucida



CODICE	mm	A/mm	B/mm	E/mm	L/mm	€/Pz
FG 629/A19	19	33.0	29.2	14.0	50.0	11,90
FG 629/A22	22	36.0	32.2	14.0	50.0	12,40
FG 629/A23	23	36.0	33.2	14.0	50.0	12,40
FG 629/A24	24	36.0	33.2	14.0	50.0	13,50
FG 629/A26	26	36.0	37.0	22.0	52.0	14,20
FG 629/A27	27	36.0	38.0	22.0	52.0	14,20
FG 629/A28	28	36.0	39.0	22.0	52.0	14,70
FG 629/A29	29	38.0	40.0	22.0	52.0	14,70
FG 629/A30	30	38.0	42.0	24.0	54.0	15,90
FG 629/A32	32	38.0	44.0	26.0	56.0	15,90

CODICE	mm	A/mm	B/mm	E/mm	L/mm	€/Pz
FG 629/A33	33	38.0	46.0	26.0	56.0	17,00
FG 629/A34	34	38.0	47.0	26.0	56.0	17,00
FG 629/A35	35	42.0	48.0	26.0	58.0	18,50
FG 629/A36	36	42.0	50.0	28.0	58.0	18,50
FG 629/A38	38	45.0	52.0	28.0	60.0	20,10
FG 629/A41	41	45.0	56.0	30.0	64.0	21,60
FG 629/A46	46	48.0	62.0	34.0	68.0	29,50
FG 629/A50	50	48.0	68.0	36.0	72.0	34,50
FG 629/A55	55	48.0	74.0	40.0	76.0	42,00
FG 629/A60	60	48.0	80.0	42.0	78.0	48,00

CHIAVE A BUSSOLA 3/4" POLIGONALI

UTILIZZO

bulloni esagonali e poligonali

FINITURA

cromata lucida

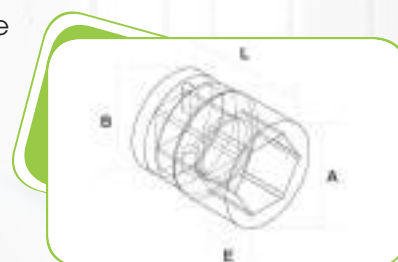

CODICE	mm	A/mm	B/mm	E/mm	L/mm	€/Pz
FG 629/B19	19	33.0	29.2	14.0	50.0	11,90
FG 629/B22	22	36.0	32.2	14.0	50.0	12,40
FG 629/B23	23	36.0	33.2	14.0	50.0	12,40
FG 629/B24	24	36.0	33.2	14.0	50.0	13,50
FG 629/B26	26	36.0	37.0	22.0	52.0	14,20
FG 629/B27	27	36.0	38.0	22.0	52.0	14,20
FG 629/B28	28	36.0	39.0	22.0	52.0	14,70
FG 629/B29	29	38.0	40.0	22.0	52.0	14,70
FG 629/B30	30	38.0	42.0	24.0	54.0	15,90
FG 629/B32	32	38.0	44.0	26.0	56.0	15,90

CODICE	mm	A/mm	B/mm	E/mm	L/mm	€/Pz
FG 629/B33	33	38.0	46.0	26.0	56.0	17,00
FG 629/B34	34	38.0	47.0	26.0	56.0	17,00
FG 629/B35	35	42.0	48.0	26.0	58.0	18,50
FG 629/B36	36	42.0	50.0	28.0	58.0	18,50
FG 629/B38	38	45.0	52.0	28.0	60.0	20,10
FG 629/B41	41	45.0	56.0	30.0	64.0	21,60
FG 629/B46	46	48.0	62.0	34.0	68.0	29,50
FG 629/B50	50	48.0	68.0	36.0	72.0	34,50
FG 629/B55	55	48.0	74.0	40.0	76.0	42,00
FG 629/B60	60	48.0	80.0	42.0	78.0	48,00



Set bussole ESAGONALI da 3/4"

CODICE	CONTENUTO	€/Pz
FG 629A/S10	10pz	410,00

Set bussole POLIGONALI da 3/4"

CODICE	CONTENUTO	€/Pz
FG 629B/S10	10pz	410,00

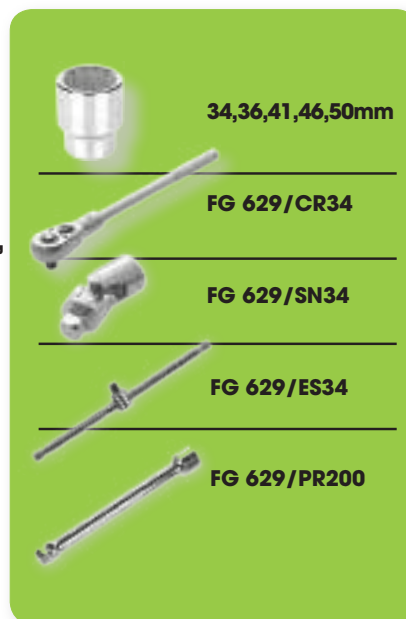

34,36,41,46,50mm

FG 629/CR34

FG 629/SN34

FG 629/ES34

FG 629/PR200



Set bussole ESAGONALI da 3/4"

CODICE	CONTENUTO	€/Pz
FG 629A/S15	15pz	490,00

Set bussole POLIGONALI da 3/4"

CODICE	CONTENUTO	€/Pz
FG 629B/S15	15pz	490,00

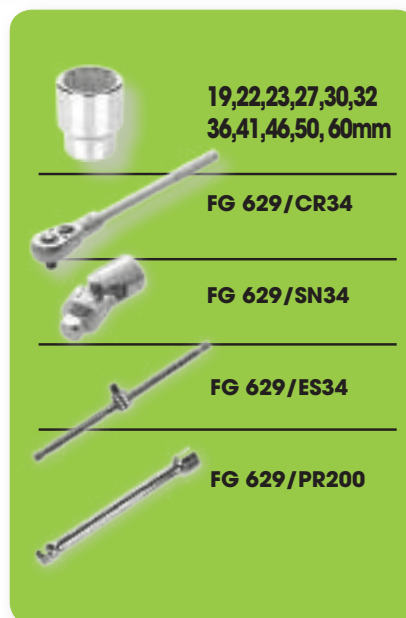

19,22,23,27,30,32
36,41,46,50, 60mm

FG 629/CR34

FG 629/SN34

FG 629/ES34

FG 629/PR200



Modulo bussole ESAGONALI 3/4"

CODICE	CONTENUTO	€/Pz
FG 100/25	10pz	375,00

Modulo bussole POLIGONALI 3/4"

CODICE	CONTENUTO	€/Pz
FG 100/25B	10pz	375,00

Modulo bussole ESAGONALI 3/4"

CODICE	CONTENUTO	€/Pz
FG 102/25	10pz	350,00

Modulo bussole POLIGONALI 3/4"

CODICE	CONTENUTO	€/Pz
FG 102/25B	10pz	350,00

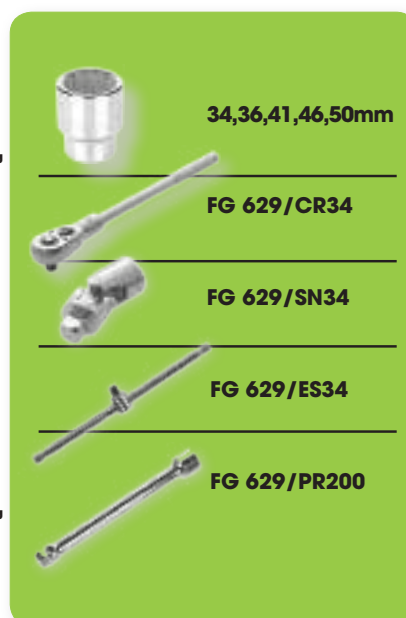

34,36,41,46,50mm

FG 629/CR34

FG 629/SN34

FG 629/ES34

FG 629/PR200



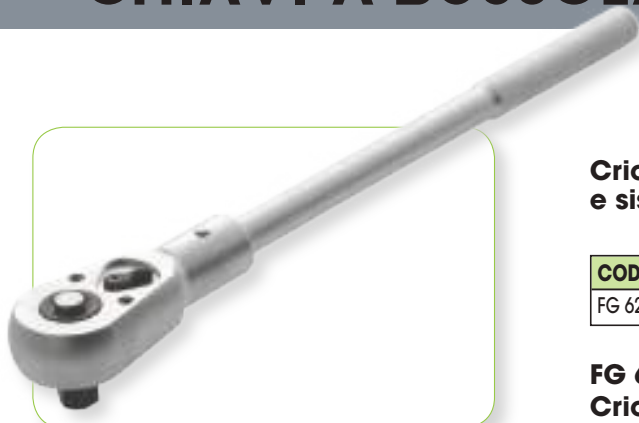

Cricchetto reversibile a 40 denti con attacco quadro 3/4" e sistema di aggancio/sgancio rapido

CODICE	■	L/mm	€/Pz
FG 629/CR34	3/4"	500	110,00

FG 629/CR34R
Cricco di ricambio - €/Pz: 45,00



Prolunga con attacco quadro maschio e femmina 3/4"

CODICE	L/mm	€/Pz
FG 629/PR200	200	23,00
FG 629/PR400	400	35,00



Prolunga a L con attacco quadro maschio 3/4"

CODICE	L/mm	€/Pz
FG 629/PRL	455	36,00

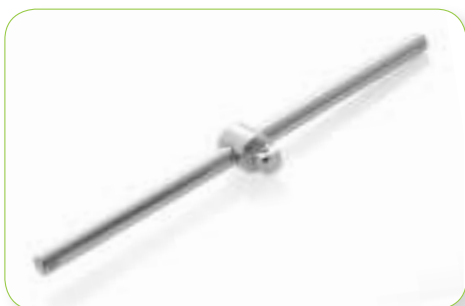

Quadro maschio con attacco scorrevole 3/4"

CODICE	L/mm	€/Pz
FG 629/ES34	405	35,00



Quadro maschio snodato con attacco maschio 3/4"

CODICE	L/mm	€/Pz
FG 629/QS34	500	55,00



Snodo con attacco quadro maschio e femmina 3/4"

CODICE	L/mm	€/Pz
FG 629/SN34	105	55,00

CHIAVE A BUSSOLA 1" POLIGONALI

- UTILIZZO

bulloni esagonali e poligonali

- FINITURA

cromata lucida

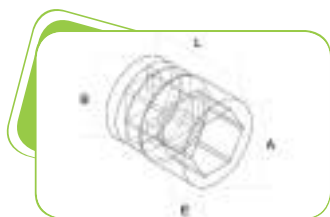

CODICE	mm	A/mm	B/mm	E/mm	L/mm	€/Pz
FG 630/B36	36	52.0	55.0	62.0	21.0	31,00
FG 630/B41	41	52.0	61.5	62.0	26.0	31,00
FG 630/B46	46	58.0	68.0	64.0	27.0	34,00
FG 630/B50	50	58.0	72.9	70.0	31.0	40,20
FG 630/B55	55	58.0	79.0	70.0	31.0	42,80
FG 630/B60	60	62.0	87.1	78.0	35.0	51,00
FG 630/B65	65	62.0	93.0	80.0	36.0	61,00
FG 630/B70	70	62.0	98.0	85.0	40.0	69,00
FG 630/B75	75	86.0	103.9	95.0	48.0	76,50
FG 630/B80	80	86.0	110.0	98.0	52.0	85,00

Cricchetto reversibile da 1" a 24 denti e sistema di aggancio/sgancio rapido

CODICE	■	L/mm	€/Pz
FG 630/CR1	1"	650	160,00



Prolunga con attacco quadro maschio e femmina 1"

CODICE	L/mm	€/Pz
FG 630/PR200	200	41,00
FG 630/PR400	400	60,00



Quadro maschio con attacco scorrevole 1"

CODICE	L/mm	€/Pz
FG 630/ES1	550	74,00



Set bussole POLIGONALI da 1"

CODICE	PZ	€/Pz
FG 630B/S8	12	876,00

46,50,55,60, 65,70,75,80mm

FG 630/CR1

FG 630/ES1

FG 630/PR200

FG 630/PR400



Chiave a bussola 3/8" esagonale rinforzate



CODICE	mm	A/mm	B/mm	D/mm	E/mm	€/Pz
FG 627/C8	8	13,0	17,7	30,0	10,9	5,50
FG 627/C9	9	14,3	17,8	30,0	11,5	5,50
FG 627/C10	10	15,5	17,8	30,0	11,7	5,50
FG 627/C11	11	16,7	17,8	30,0	11,8	5,50
FG 627/C12	10	17,8	17,8	30,0	11,5	5,50
FG 627/C13	13	19,8	19,8	30,0	11,5	6,00
FG 627/C14	14	21,9	21,9	30,0	16,4	6,00
FG 627/C15	15	23,9	23,9	30,0	16,5	6,00
FG 627/C16	16	23,9	23,9	30,0	16,5	6,00
FG 627/C17	17	25,8	25,8	30,0	16,5	6,00
FG 627/C18	18	27,9	27,9	30,0	16,5	6,20
FG 627/C19	19	27,8	27,9	30,0	16,5	6,20
FG 627/C20	20	29,8	29,8	30,0	16,5	7,00
FG 627/C21	21	29,8	29,9	30,0	17,0	7,00
FG 627/C22	22	31,9	31,9	30,0	17,0	7,50

Set 15 chiavi a bussola rinforzate da 3/8" in cassetta di ABS

CODICE	Pz	CONTENUTO	€/Pz
FG 627/S15B	15	8,9,10, 11, 12, 13, 14, 15, 16, 17, 18, 19, 20, 21, 22mm	102,00

Chiave a bussola 1/2" esagonale rinforzata



CODICE	mm	A/mm	B/mm	C/mm	L/mm	€/Pz
FG 628/L10	10	17,5	25	13	80	13,00
FG 628/L11	11	19,0	25	13	80	13,00
FG 628/L12	12	20,0	25	13	80	13,00
FG 628/L13	13	21,0	25	13	80	13,00
FG 628/L14	14	23,0	25	13	80	13,00
FG 628/L15	15	24,0	25	13	80	13,00
FG 628/L16	16	25,0	25	13	80	13,00
FG 628/L17	17	26,5	30	17	80	13,00

CODICE	mm	A/mm	B/mm	D/mm	E/mm	€/Pz
FG 628/L18	18	28,0	30	18	80	16,00
FG 628/L19	19	29,0	30	19	80	16,00
FG 628/L21	21	32,0	30	21	80	17,00
FG 628/L22	22	33,0	30	22	80	17,00
FG 628/L23	23	34,0	30	23	80	17,50
FG 628/L24	24	35,0	30	24	80	17,50
FG 628/L25	25	36,5	30	25	80	21,50
FG 628/L27	27	39,0	30	27	80	21,50
FG 628/L29	29	42,5	30	30	80	28,50
FG 628/L30	30	43,5	30	30	80	28,50
FG 628/L32	32	44,5	30	32	80	28,50



Set 19 chiavi a bussola rinforzate da 1/2" in cassetta di ABS

CODICE	Pz	CONTENUTO	€/Pz
FG 628/LS19	19	10, 11, 12, 13, 14, 15, 16, 17, 18, 19, 21, 22, 23, 24, 25, 27, 29, 30, 32 mm	360,00

Chiave a bussola 1/2" esagonale rinforzate

CODICE	mm	A/mm	B/mm	D/mm	E/mm	€/Pz
FG 628/C10	10	15.6	22.6	38.1	7.1	7,00
FG 628/C11	11	17.8	22.6	38.1	8.4	7,00
FG 628/C12	12	18.2	24.3	38.1	9.7	7,00
FG 628/C13	13	19.3	24.3	38.1	9.7	7,00
FG 628/C14	14	22.0	24.3	38.1	10.7	7,00
FG 628/C15	15	23.2	26.6	38.1	10.7	8,00
FG 628/C16	16	24.3	26.6	38.1	11.9	8,00
FG 628/C17	17	25.4	26.6	38.1	12.7	8,00
FG 628/C18	18	26.6	26.6	38.1	12.7	8,00
FG 628/C19	19	28.3	28.3	38.1	12.7	8,00
FG 628/C20	20	29.9	29.9	38.1	14.2	8,00
FG 628/C21	21	31.5	31.5	38.1	14.2	9,00
FG 628/C22	22	33.1	33.3	38.1	14.2	9,00



CODICE	mm	A/mm	B/mm	D/mm	E/mm	€/Pz
FG 628/C23	23	34.0	34.0	44.5	16.3	9,50
FG 628/C24	24	34.8	34.8	44.5	16.3	9,50
FG 628/C25	25	36.4	36.4	44.5	19.6	10,50
FG 628/C26	26	37.8	37.8	50.8	19.8	11,50
FG 628/C27	27	39.4	39.4	50.8	20.3	11,50
FG 628/C30	30	43.5	41.5	51.5	21.4	12,50
FG 628/C32	32	44.5	41.5	51.5	21.8	14,50

Set 10 chiavi a bussola rinforzate da 1/2" su supporto in plastica

CODICE	Pz	CONTENUTO	€/Pz
FG 628/S10	10	10, 11, 12, 13, 15, 16, 17, 18, 19, 21 mm	85,00



Set 20 chiavi a bussola rinforzate da 1/2" in cassetta di ABS

CODICE	Pz	CONTENUTO	€/Pz
FG 628/S20	20	10, 11, 12, 13, 14, 15, 16, 17, 18, 19, 20, 21, 22, 23, 24, 25, 26, 27, 30, 32mm	220,00

Chiave a bussola 1/2" rinforzata con impronta Torx

CODICE	E	A/mm	B/mm	D/mm	E/mm	€/Pz
FG 628/TX8	8	13.0	21.8	38.0	14.0	9,50
FG 628/TX10	10	14.0	21.8	38.0	14.0	9,50
FG 628/TX12	12	15.0	21.8	38.0	14.0	10,50
FG 628/TX14	14	17.0	21.8	38.0	14.0	10,50
FG 628/TX16	16	18.0	21.8	38.0	14.0	10,50
FG 628/TX18	18	20.0	21.8	38.0	14.0	10,50
FG 628/TX20	20	24.0	21.8	38.0	14.0	10,50
FG 628/TX22	22	25.8	24.0	38.0	14.0	11,50
FG 628/TX24	24	27.8	26.0	38.0	14.0	11,50



Set 9 chiavi a bussola rinforzate da 1/2" Torx su supporto in plastica

CODICE	Pz	CONTENUTO	€/Pz
FG 628/TXS9	9	E8, E10, E12, E14, E16, E18, E20, E22, E24	98,00



Chiave a bussola 1/2" rinforzata con impronta Torx

CODICE	E	A/mm	B/mm	C/mm	L/mm	€/Pz
FG 628L/TX10	10	13.2	25.0	9.5	70.0	11,50
FG 628L/TX12	12	13.6	25.0	10.5	70.0	11,50
FG 628L/TX14	14	16.4	25.0	12.7	70.0	11,50
FG 628L/TX16	16	19.0	25.0	14.0	70.0	12,50
FG 628L/TX18	18	21.4	25.0	15.0	70.0	12,50
FG 628L/TX20	20	23.5	25.0	17.5	70.0	13,50
FG 628L/TX22	22	26.0	25.0	20.0	70.0	13,50
FG 628L/TX24	24	28.0	25.0	23.4	70.0	13,50



Set 8 chiavi a bussola rinforzate da 1/2" Torx su supporto in plastica

CODICE	Pz	CONTENUTO	€/Pz
FG 628L/TXS8	8	E10, E12, E14, E16, E18, E20, E22, E24	108,00



Chiave a bussola 1/2" esagonale rinforzate



EXTRA PATA



CODICE	mm	A/mm	B/mm	D/mm	E/mm	€/Pz
FG 628/D10	10	17.0	23.8	28.0	7.0	7,50
FG 628/D11	11	18.0	23.9	28.0	5.5	7,50
FG 628/D12	12	19.0	23.9	28.0	7.0	7,50
FG 628/D13	13	19.8	24.0	28.0	8.0	7,50
FG 628/D14	14	22.0	24.0	28.0	6.5	7,50
FG 628/D15	15	24.0	24.0	28.0	7.5	8,50
FG 628/D16	16	24.0	24.0	28.0	7.0	8,50
FG 628/D17	17	26.0	26.0	28.0	8.0	8,50
FG 628/D18	18	28.0	28.0	28.0	7.0	8,50

CODICE	mm	A/mm	B/mm	D/mm	E/mm	€/Pz
FG 628/D19	19	28.0	28.0	28.0	8.5	8,50
FG 628/D20	20	30.0	30.0	28.0	8.5	8,50
FG 628/D21	21	30.0	30.0	28.0	8.0	9,50
FG 628/D22	22	32.0	28.0	28.0	9.0	9,50
FG 628/D23	23	33.0	28.0	28.0	9.0	10,00
FG 628/D24	24	34.0	30.0	28.0	9.0	10,00
FG 628/D27	27	38.0	30.0	28.0	10.0	12,00
FG 628/D30	30	42.0	34.0	28.0	10.0	13,00
FG 628/D32	32	44.0	36.0	28.0	9.0	15,00

Set 12 chiavi a bussola rinforzate da 1/2" su supporto in plastica

CODICE	Pz	CONTENUTO	€/Pz
FG 628/S12	12	10, 11, 12, 13, 14, 15, 16, 17, 18, 19, 20, 21 mm	115,00

Set 6 chiavi a bussola rinforzate da 1/2" su supporto in plastica

CODICE	Pz	CONTENUTO	€/Pz
FG 628/S6	6	22, 23, 24, 27, 30, 32mm	84,00

Prolunga rinforzata con attacco quadro maschio e femmina 1/2"

CODICE	L/mm	€/Pz
FG 628/PR125	125	13,00
FG 628/PR250	250	14,00
FG 628/PR380	380	15,00

Set 3 prolunghie rinforzate con attacco quadro maschio e femmina 1/2"

CODICE	Pz	CONTENUTO	€/Pz
FG 628PR/S3	3	125, 250, 380mm	42,00

CHIAVI A BUSSOLA PER SERRAGGIO GHIERE KM

→ **UTILIZZO** ghiera KM con denti ESTERNI

→ **FINITURA** brunita

CODE	KM	THREAD mm.	D/mm	D1/mm	Pins	Drive	€/Pz
FG 631/KM4	4	20x1	32.0	28.0	4	1/2"	35,00
FG 631/KM5	5	25x1.5	38.0	34.0	4	1/2"	37,00
FG 631/KM6	6	30x1.5	45.0	40.0	4	1/2"	45,30
FG 631/KM7	7	35x1.5	52.0	48.0	4	1/2"	51,50
FG 631/KM8	8	40x1.5	58.0	52.0	4	1/2"	56,00
FG 631/KM9	9	45x1.5	65.0	59.0	4	3/4"	67,00
FG 631/KM10	10	50x1.5	70.0	65.0	4	3/4"	70,00
FG 631/KM11	11	55x2	75.0	67.0	4	3/4"	74,00
FG 631/KM12	12	60x2	80.0	73.0	4	3/4"	80,50

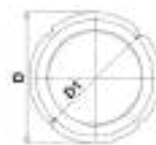

CHIAVI A BUSSOLA PER SERRAGGIO GHIERE KM

→ **UTILIZZO** ghiera KM con denti INTERNI

→ **FINITURA** brunita

CODICE	KM	FILETTO mm.	D/mm	D1/mm	Num denti	Affacco	€/Pz
FG 632/KM4	4	20x1	37.5	28.0	4	1/2"	33,00
FG 632/KM5	5	25x1.5	44.5	34.0	4	1/2"	35,00
FG 632/KM6	6	30x1.5	52.5	41.0	4	1/2"	45,00
FG 632/KM7	7	35x1.5	59.5	48.0	4	1/2"	50,00
FG 632/KM8	8	40x1.5	65.5	52.0	4	1/2"	55,00
FG 632/KM9	9	45x1.5	73.5	60.0	4	3/4"	64,70
FG 632/KM10	10	50x1.5	70.0	65.0	4	3/4"	69,50
FG 632/KM11	11	55x2	83.0	69.0	4	3/4"	73,30
FG 632/KM12	12	60x2	88.0	74.0	4	3/4"	76,50

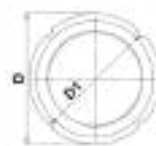

Set 9 chiavi a bussola per ghiera KM con denti ESTERNI

CODICE	Pz	CONTENUTO	€/Pz
FG 631/S9	9	KM4 - KM12	570,00

Set 9 chiavi a bussola per ghiera KM con denti INTERNI

CODICE	Pz	CONTENUTO	€/Pz
FG 632/S9	9	KM4 - KM12	605,00



CHIAVE A BUSSOLA RINFORZATA ESAGONALE 3/4"

→ **UTILIZZO** bulloni Esagonali → **FINITURA** brunita

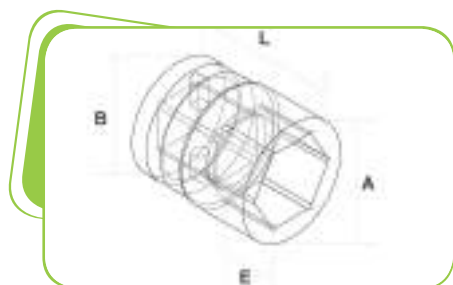

CODICE	mm	A/mm	B/mm	E/mm	L/mm	€/Pz
FG 629/C17	17	30.0	44.0	14.0	51.0	19,50
FG 629/C18	18	31.0	44.0	14.0	51.0	19,50
FG 629/C19	19	32.5	44.0	14.0	51.0	19,50
FG 629/C21	21	35.0	44.0	14.0	51.0	19,50
FG 629/C22	22	36.0	44.0	14.0	51.0	19,50
FG 629/C23	23	37.5	44.0	14.0	51.0	19,90
FG 629/C24	24	38.5	44.0	14.0	51.0	19,90
FG 629/C27	27	42.5	44.0	20.0	53.0	19,90
FG 629/C28	28	44.0	44.0	20.0	53.0	19,90
FG 629/C30	30	46.0	44.0	20.0	53.0	19,90
FG 629/C32	32	48.5	44.0	21.0	57.0	20,50

CODICE	mm	A/mm	B/mm	E/mm	L/mm	€/Pz
FG 629/C33	33	50.0	44.0	21.0	57.0	22,50
FG 629/C34	34	51.0	44.0	21.0	57.0	22,50
FG 629/C36	36	53.5	44.0	21.0	57.0	24,00
FG 629/C40	40	58.5	44.0	22.0	58.0	28,00
FG 629/C41	41	60.0	44.0	22.0	58.0	28,00
FG 629/C46	46	66.0	44.0	25.0	62.0	34,00
FG 629/C50	50	71.0	44.0	30.0	68.0	43,00
FG 629/C54	54	76.0	54.0	32.0	72.0	45,00
FG 629/C55	55	77.5	54.0	32.0	72.0	45,00
FG 629/C58	58	81.0	54.0	32.0	72.0	52,50
FG 629/C60	60	83.5	54.0	32.0	72.0	52,50



Set 10 chiavi a bussola rinforzate esagonali da 3/4"
in cassetta di acciaio

CODICE	Pz	CONTENUTO	€/Pz
FG 629C/S10	10	17, 19, 22, 24, 27, 30, 32, 36, 41, 46mm	249,50

CHIAVE A BUSSOLA RINFORZATA ESAGONALE 3/4" serie lunga

→ **UTILIZZO** bulloni Esagonali → **FINITURA** brunita

CODICE	mm	A/mm	B/mm	C/mm	L/mm	€/Pz
FG 629/L17	17	30.0	44.0	26.0	90.0	30,00
FG 629/L19	19	32.5	44.0	26.0	90.0	30,00
FG 629/L21	21	35.0	44.0	26.0	90.0	30,00
FG 629/L22	22	36.0	44.0	26.0	90.0	30,00
FG 629/L24	24	38.5	44.0	26.0	90.0	30,00
FG 629/L26	26	38.5	44.0	28.0	90.0	30,00
FG 629/L27	27	42.5	44.0	28.0	90.0	30,00
FG 629/L30	30	46.0	44.0	28.0	90.0	32,00
FG 629/L32	32	48.5	44.0	28.0	90.0	33,00
FG 629/L33	33	50.0	44.0	30.0	90.0	35,00
FG 629/L34	34	51.0	44.0	30.0	90.0	38,00
FG 629/L36	36	53.5	44.0	30.0	90.0	40,00
FG 629/L38	38	56.0	44.0	34.0	90.0	40,00
FG 629/L41	41	60.0	44.0	34.0	90.0	47,00
FG 629/L46	46	66.0	44.0	34.0	90.0	55,00
FG 629/L50	50	71.0	44.0	36.0	90.0	65,00

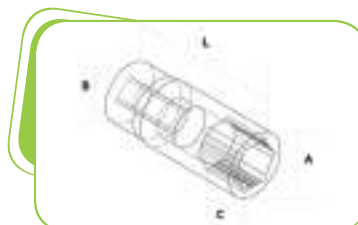

CHIAVE A BUSSOLA RINFORZATA ESAGONALE 1"

- **UTILIZZO** bulloni esagonali

- **FINITURA** brunita

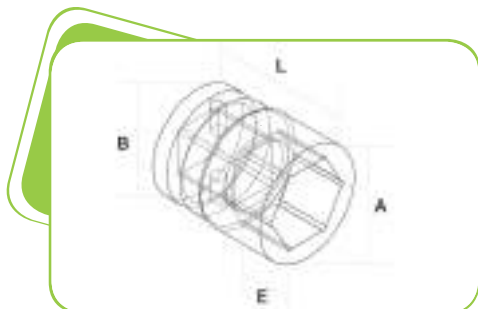

CODICE	mm	A/mm	B/mm	L/mm	E/mm	€/Pz
FG 630/A24	24	51.0	39.9	58.0	17.0	31,00
FG 630/A27	27	51.0	43.9	58.0	17.0	31,00
FG 630/A30	30	51.0	48.0	60.0	21.0	31,00
FG 630/A32	32	51.0	51.0	60.0	21.0	32,00
FG 630/A33	33	52.0	53.0	62.0	21.0	32,00
FG 630/A34	34	52.0	53.5	62.0	21.0	32,00
FG 630/A36	36	52.0	55.0	62.0	21.0	32,00
FG 630/A38	38	52.0	57.9	62.0	26.0	39,00

CODICE	mm	A/mm	B/mm	L/mm	E/mm	€/Pz
FG 630/A41	41	52.0	61.5	62.0	26.0	40,50
FG 630/A46	46	58.0	68.0	64.0	27.0	44,50
FG 630/A50	50	58.0	72.9	70.0	31.0	56,70
FG 630/A55	55	58.0	79.0	70.0	31.0	60,80
FG 630/A60	60	62.0	87.1	78.0	35.0	74,20
FG 630/A65	65	62.0	93.0	80.0	36.0	84,50
FG 630/A70	70	62.0	98.0	85.0	40.0	94,80
FG 630/A75	75	86.0	103.9	95.0	48.0	125,00
FG 630/A80	80	86.0	110.0	98.0	52.0	129,00



Set 14 chiavi a bussola rinforzate esagonali 1" in cassetta di acciaio

CODICE	Pz	CONTENUTO	€/Pz
FG 630A/S14	14	24, 27, 30, 32, 33, 34, 36, 38, 41, 46, 50, 55, 60, 65mm	745,00

CHIAVE A BUSSOLA RINFORZATA ESAGONALE 1"

- **UTILIZZO** bulloni esagonali

- **FINITURA** brunita

CODICE	mm	A/mm	B/mm	C/mm	L/mm	€/Pz
FG 630/L24	24	51.0	51.0	17.0	108.0	47,50
FG 630/L27	27	51.0	51.0	17.0	108.0	48,50
FG 630/L30	30	51.0	51.0	21.0	108.0	49,50
FG 630/L32	32	51.0	51.0	21.0	108.0	51,00
FG 630/L33	33	52.0	52.0	21.0	108.0	52,50
FG 630/L34	34	52.0	52.0	21.0	108.0	57,00
FG 630/L36	36	52.0	52.0	21.0	108.0	57,00
FG 630/L41	41	52.0	61.5	26.0	108.0	61,50
FG 630/L46	46	52.0	61.5	26.0	108.0	65,50
FG 630/L50	50	58.0	68.0	27.0	108.0	73,50
FG 630/L55	55	58.0	72.9	31.0	108.0	105,00
FG 630/L60	60	58.0	79.0	31.0	108.0	125,00
FG 630/L65	65	62.0	87.1	35.0	108.0	137,00
FG 630/L70	70	62.0	93.0	36.0	108.0	157,00

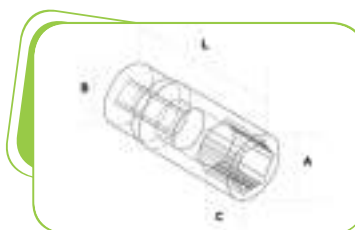



Adattatore manuale

1/4"

CODICE	□	■	L/mm	€/Pz
FG 624/AD1	1/4"	3/8"	28	4,50



Adattatore manuale

3/8"

CODICE	□	■	L/mm	€/Pz
FG 624/AD2	3/8"	1/4"	30	5,50
FG 624/AD3	3/8"	1/2"	30	7,00



Adattatore manuale

1/2"

CODICE	□	■	L/mm	€/Pz
FG 625/AD1	1/2"	1/4"	28	8,50
FG 625/AD2	1/2"	3/8"	30	9,00
FG 625/AD3	1/2"	3/4"	28	9,50



Adattatore manuale

3/4"

CODICE	□	■	L/mm	€/Pz
FG 629/AD3	3/4"	1/2"	30	13,10



Set 7 adattatori manuali e 3 snodi per chiavi a bussola

CODICE	CONTENUTO □ x ■	€/Pz
FG 625AD/S10	1/4"x3/8", 3/8"x1/4", 3/8"x1/2", 1/2"x1/4", 1/2"x3/8", 1/2"x3/4", 3/4"x1/2"	65,00



Adattatori magnetici - EXTRA PIATTI

CODICE	□	■	L/mm	€/Pz
FG 624/AM1	1/4"	3/8"	13.6	7,60
FG 624/AM2	3/8"	1/2"	18.4	10,50
FG 625/AM3	1/2"	3/4"	27.5	15,50



Set 3 adattatori magnetici EXTRA PIATTI

CODICE	CONTENUTO □ x ■	€/Pz
FG 625AM/S3	1/4"x3/8", 3/8"x1/2", 1/2"x3/4"	40,00



Adattatore rinforzato per chiavi a bussola

CODICE	□	■	L/mm	€/Pz
FG 624/AD4	1/4"	3/8"	28	9,50

1/4"



Adattatore rinforzato per chiavi a bussola

CODICE	□	■	L/mm	€/Pz
FG 624/AD5	3/8"	1/2"	30	12,60

3/8"



Adattatore rinforzato per chiavi a bussola

CODICE	□	■	L/mm	€/Pz
FG 628/AD1	1/2"	1/4"	28	15,80
FG 628/AD2	1/2"	3/8"	30	16,80
FG 628/AD3	1/2"	3/4"	28	19,90

1/2"



Adattatore rinforzato per chiavi a bussola

CODICE	□	■	L/mm	€/Pz
FG 629/AD1	3/4"	1/2"	30	26,50
FG 629/AD2	3/4"	1"	28	29,90

3/4"

CODICE	ADATTO PER:	€/Pz
FG 629/AS1	Coppia di spina + anello 3/4"	4,50



Adattatore rinforzato per chiavi a bussola

CODICE	□	■	L/mm	€/Pz
FG 630/AD1	1"	3/4"	30	38,00

1"

CODICE	ADATTO PER:	€/Pz
FG 630/AS1	Coppia di spina + anello 1"	5,80



Snodo con attacco quadro maschio e femmina

CODICE	L/mm	€/Pz
FG 625/SN12R	105	31,50
FG 629/SN34R	105	63,00

1/2"

3/4"

